

DOORS



— 2022 —

# DOORS

ENTRY | PATIO | STORM



# PROVIA® BUILDS DOORS THE PROFESSIONAL WAY

---

ProVia has developed a competitive position by catering to a niche within the door market that demands a high degree of customization coupled with outstanding quality. Our company defines the products that meet this demand as “professional-class.” We have found success by adhering to a set of core values that guide us as we develop rewarding, long-term relationships with our employees, customers and homeowners.

## WHAT MAKES PROVIA PROFESSIONAL-CLASS?

---

### ENTRY SYSTEMS **TAILORED** FOR YOUR HOME

Today’s off-the-rack consumer-grade doors, which are mass-produced and not customized for your home, often fall short of expectations and performance.

These shortcomings are the driving force behind ProVia’s custom entry doors, built to your home’s exact measurements for a precise fit, protection, security, and energy efficiency. The materials that go into our custom-made doors are premium quality and exceptionally durable, far surpassing the ready-made doors at the big-box hardware stores, and our craftsmanship and care for details can be seen in each door we produce.



**SECURITY** | We ensure the strength and security of every door, so you have peace of mind and can focus on what’s really important - your life.



**DURABILITY** | Crafted with the finest materials and backed by our Lifetime Limited Transferable Warranty, the durability of our products can’t be beat.



**BEAUTY** | A beautiful ProVia entry system will always greet your guests with classic elegance and style.



**ENERGY EFFICIENCY** | Engineered to keep the elements at bay and your home comfortable all year long.







## INDUSTRY ASSOCIATION

ProVia is a proud member of the Window and Door Manufacturers Association (WDMA) and American Architectural Manufacturers Association (AAMA) - leading voices in our industry. As such, we support advocacy in building code and ASTM standard arenas, quality materials, installation and design in Doors and Windows.

## ENTRY DOORS

### DOOR TYPE

Components.....	6-9
Embarq® Fiberglass Features.....	10
Signet® Fiberglass Features.....	14
Heritage™ Fiberglass Features.....	16
Legacy™ Steel Features.....	18
8' Doors.....	20
French Doors.....	22
Inscribed Doors.....	24
Doors Without Glass.....	26

### GLASS

#### ComforTech™ Glazing Systems

ComforTech Benefits.....	28
--------------------------	----

#### Decorative Glass

Mirage.....	32
Brookhaven.....	34
Manhattan.....	36
Essence.....	38
Cheyenne.....	40
Symphony.....	42
Berkley.....	44
Laurence.....	46
Carrington.....	48
Tacoma.....	50
Somerset.....	52
Carmen.....	54
Barcelona.....	56
Constance.....	58
Tranquility.....	60
Gemstone.....	62
Eclipse.....	64
Florence.....	66
Esmond.....	68
Carlisle.....	70
Twilight.....	72

#### Inspirations™ Art Glass

Inspirations™ Art Glass.....	76
------------------------------	----

#### Privacy Glass

Privacy Glass.....	78
--------------------	----

#### Clear Glass

Clear Glass.....	80
White Internal Blinds.....	82
Colored Internal Blinds.....	84
Simulated Divided Lites.....	86
Simulated Divided Panels.....	88
Internal Grids.....	90
External Grids.....	93

### NEW Glass Availability Charts

#### FINISHING TOUCHES

Stain Finishes.....	94
Paint Finishes.....	98
Trending/Custom Colors.....	100
Hardware.....	102
Speakeasy, Hinge Straps, Clavos.....	120
Pet Doors.....	122
Casing.....	123
Cladding.....	123

## PATIO DOORS

Hinged Patio Doors.....	124
Vinyl Sliding Patio Doors.....	126

## STORM DOORS

Features and Benefits.....	132
Paint Colors.....	135
Spectrum™.....	136
Decorator™.....	138
Deluxe™.....	140
DuraGuard™.....	142
Superview™.....	144
Hardware.....	146
Accessories.....	150

Door Type

Glass

Finishing Touches

Patio Doors

Storm Doors



WE'RE BUILDING YOUR DOORS AND OUR  
COMPANY TO LAST A LIFETIME-  
**THAT'S THE PROFESSIONAL WAY.**

**MULTI  
TIME**

Partner of the  
Year Award



**90%+** of Windows and Doors  
are ENERGY STAR®  
Certified

Serving  
alongside



**DOORS | WINDOWS | SIDING | STONE | ROOFING**



6 Facilities in the United States

**1,600+**

Associates Nationwide

Doing Business Since

**1977**

**19**

Core Values

**200+**

Metric Tons of CO<sup>2</sup>  
Saved Annually

**1,900+**

Tons of metals, paper, glass and vinyl  
recycled annually at ProVia facilities



If you ask around, you'll find attention to detail is what our customers have come to appreciate and expect from the ProVia brand. Our company is family-owned and faith-based with an intense focus on producing Professional-Class products. ProVia feels so strongly about the performance and workmanship of our entry systems—built by skilled craftspeople with state-of-the-art manufacturing processes—that they are backed with a Lifetime Limited Warranty, which is even transferable to one subsequent owner.





# STYLE YOUR WAY

TAILORED **JUST FOR YOU** AT THE HIGHEST STANDARDS.

**SECURITY | DURABILITY | BEAUTY | ENERGY EFFICIENCY**

We make it easy for you to make the choice that's right for you. When you combine your selected door style, door glass, paint or stain finish, plus hardware and accessories, the end result is a customized entryway that reflects your personalized style.



# DESIGNING YOUR DOOR

**Imagine Your Entryway with a New Look.** ProVia offers you endless possibilities to create a front door that provides a warm, welcoming entry to your home. To simplify the experience, we've categorized the selection process here to get you started. These ideas are just the beginning – you'll discover a myriad of additional color and style options throughout this catalog.

## 1 DOOR SKIN

Fiberglass and Steel door skins are available in a variety of textured and smooth options.

### FIBERGLASS

#### SIGNET SKIN OPTIONS

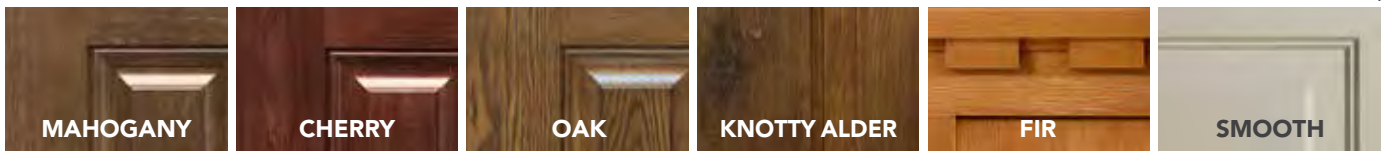

#### EMBARQ SKIN OPTIONS

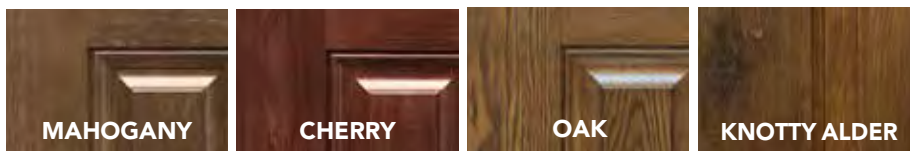

#### HERITAGE SKIN OPTIONS

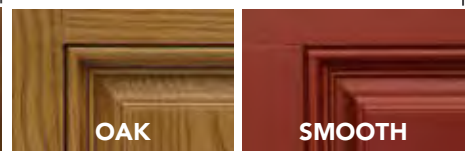

### STEEL

#### LEGACY SKIN OPTIONS



## 2 CONFIGURATION

Find and customize a configuration that best fits the opening of your home.



## 3 DOOR STYLES

Your home should reflect your personality. That's why you'll find a wide selection of styles to suit your taste.





## 4 GLASS

Select from a full line of Decorative, Art, Clear and Privacy Glass, Simulated Divided Lites, Grid Styles & Internal Blinds.



## 5 FINISH

Our stain and glazed finishes are hand-applied by professional craftsmen, then oven-cured for maximum beauty. Paint finishes are factory applied for a long-lasting, durable finish.

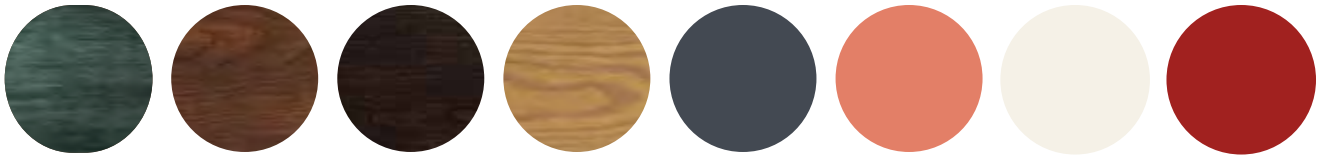

## 6 HARDWARE & ACCESSORIES

Hardware from Trilennium®, Hoppe®, Emtek®, Brinks® and Schlage® provide some of the most stylish, durable hardware available today. Sometimes the smallest things make the biggest difference. Our accessories add a lot to the look of your entry system.



## 7 ADD A STORM DOOR

Protect, enhance and ventilate your entryway with a storm door, while adding an extra measure of security.





# THE COMPONENTS

The components are the small things that set our doors apart from the competition. A lot of small things add up to a big difference.

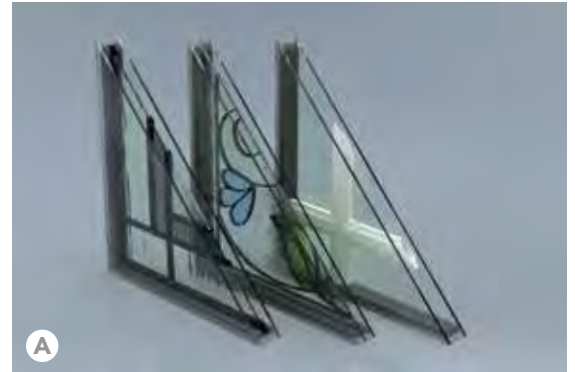

Your home is unique and deserves to have **custom glass options** like our ComforTech™ Warm Edge Glazing Systems which include decorative glass, Inspirations™ Art glass, internal blinds and internal and external grids in many grid patterns and colors.

 Impact Shield doors feature laminated glass.

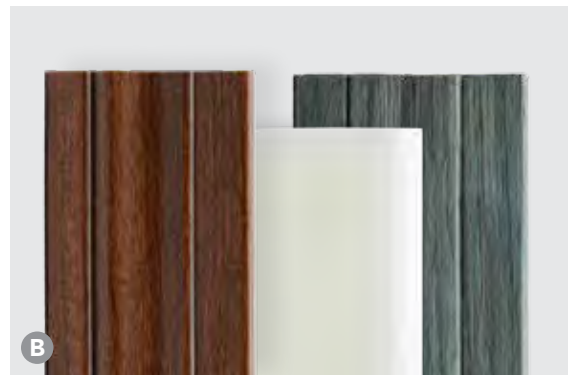

Our **2½" casing** conveniently covers paint lines providing a professional installation. **Also available in 3½"**. Choose from Cherry, Mahogany, Oak and Poplar. Flat Fir and Poplar trim are available in paint, stain and glazed finishes.

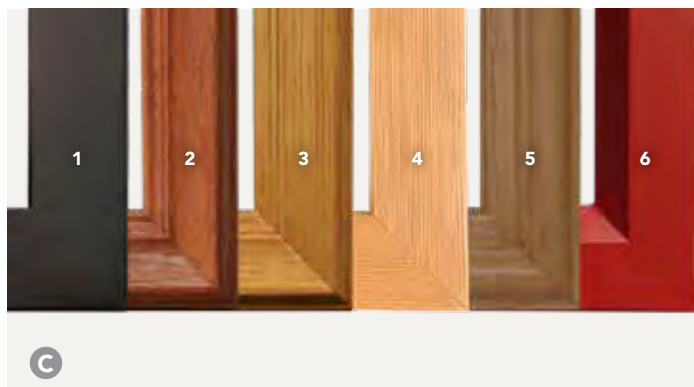

**High-performance, heat-resistant glass trim** is warranted not to warp, crack or pull away from the door, even in sunny or higher temperature applications. **Plugless glass trim** is standard on Embarq® and Signet® and optional for Heritage™† and Legacy™†.

**1.** Smooth (standard on select Signet Smooth doors and sidelites, optional on select Heritage Smooth and Legacy Smooth doors and sidelites) **2.** Embarq and Signet Cherry and Mahogany **3.** Embarq and Signet Oak and Knotty Alder **4.** Signet Fir **5.** Heritage and Legacy **6.** Modern Flat Trim (only available on models 112, 114, 115, 116 and 160 sidelites)

† See price list for available styles.



The **Z-AC™ threshold** has an auto-adjusting riser and built-in sealing system that redefines how your door can perform for you. Standard on Signet and Legacy.

- **Automatically adjusts** to your entry door's changing needs over time, eliminating service calls
- Delivers **non-stop protection** against air and water infiltration
- **Saves money** and provides an improved door experience

The **ZAI™ threshold** has a manually-adjustable riser with complementary screw cover caps. Standard on Heritage.

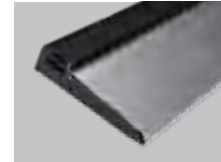

Three **heavy-duty ball bearing hinges** come standard with every entry system.

**Additional 4th hinge option** for greater durability. (only available with FrameSaver®)

 Impact Shield doors have heavy-duty stainless steel hinges.



The energy efficient **weatherstripping** runs along the top and sides of the door and interlocks with the **CornerShield™** for the most efficient seal you'll find for keeping moisture, wind and dirt out of your home.



We include our **20-gauge security plate** for extra strength and to help prevent kick-ins.

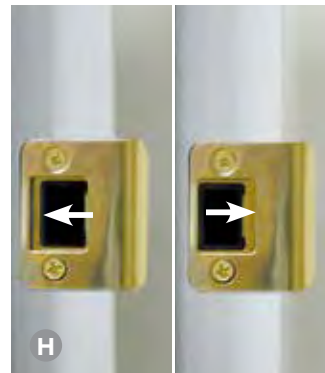

We include a **solid brass fully adjustable strike plate** of our own exclusive design. This unique 2-piece construction makes our doors easier to custom fit.



The **dust box** in the deadbolt strike provides a barrier to air infiltration while providing a nice appearance that most other door manufacturers don't provide.



**Bulb and dual blade sweep** virtually eliminates drafts, keeping your home comfortable.



# THE COMPONENTS



## FRAMES

### FrameSaver®

**FrameSaver wood frame and brickmold** with finger-jointed composite bottom prevents water absorption and carries a Lifetime Limited Warranty when used with **PVC vinyl coated aluminum frame cladding** outside.

**Also available with smooth cladding.**

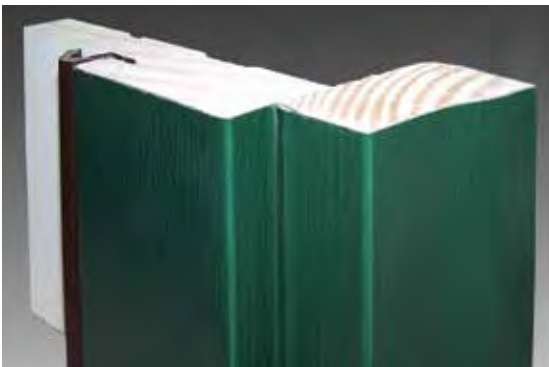

## FusionFrame™

FusionFrame: A one-of-a-kind alternative to composite or wood jambs, this Endura® component utilizes the strength of an LVL interior, the rot-proof performance of a FrameSaver® bottom, and the durability of a composite frame exterior. Offering a lifetime jamb warranty\*.

### PREFINISHED, MAINTENANCE-FREE

Available as a textured or smooth frame, providing you with the benefit of a prefinished, maintenance-free system, along with the beauty of a stain or paint finish that matches your entry door.

*Not available for transoms or outswing doors. See Price List for complete limitations and restrictions*

*\*Finish warranty will match the finish warranty of door series*

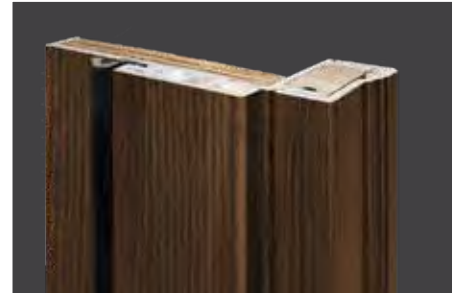
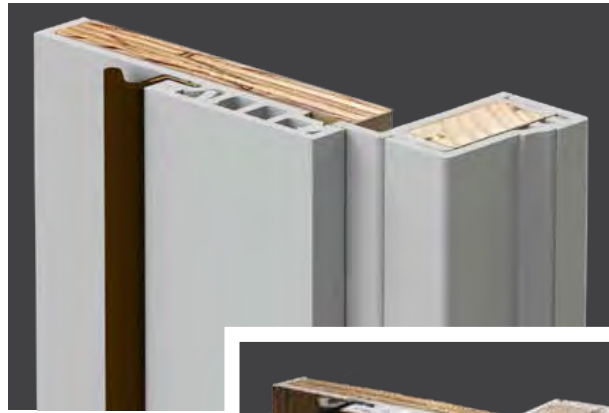

## PermaTech™



Our **PermaTech™ Composite door frame system** option combines all the strength and convenience of wood with enhanced properties that make it moisture and insect resistant. PermaTech will not absorb or wick moisture and will never rot or splinter, and is covered by a Lifetime Limited Warranty.\*

\* No storm door applied. See full warranty for limitations

## Steel L-Frame

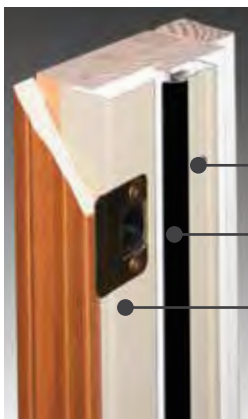

Available on select Signet and Legacy door styles

● Aluminum door stop provides greater security and is more durable than wood.

● Energy efficient weatherstripping.

● 18-gauge steel L-frame with a 12-gauge hinge plate welded on for extra strength and security.

(NOT tested for Certified Wind Load or Impact Shield regions)

Not all Steel L-Frames are ENERGY STAR® certified. Visit [provia.com](http://provia.com) website for manufacturer's certification statement.



# EMBARQ® FIBERGLASS

## EMBARQ SKIN OPTIONS



## A NEW WAY OF THINKING

We set out on a journey to develop a new door and it expanded into a complete philosophy of creating unrivaled efficiency in home building products. We call this new way of thinking "enVision," and are proud to introduce its first creation: **Embarq** – the doorway to innovation and efficiency.

**15-YEAR FINISH WARRANTY\***  
See pgs. 95-99 for paint and stain finishes



**ALL** Embarq Fiberglass Entry Systems are ENERGY STAR® Certified.

## EMBARQ FIBERGLASS DOOR STYLES

See pages 30-93 for glass availability.

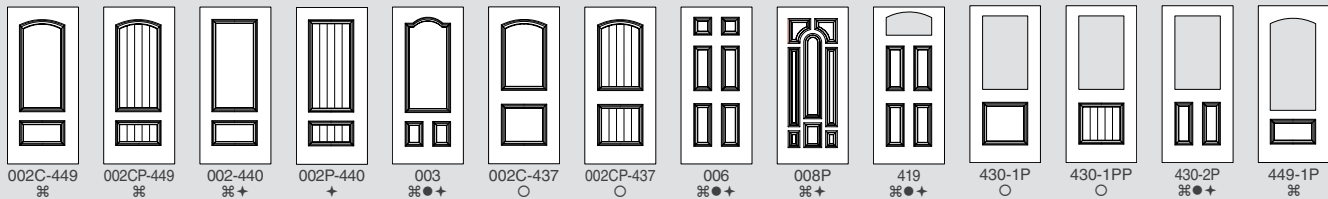

## SIDELITES

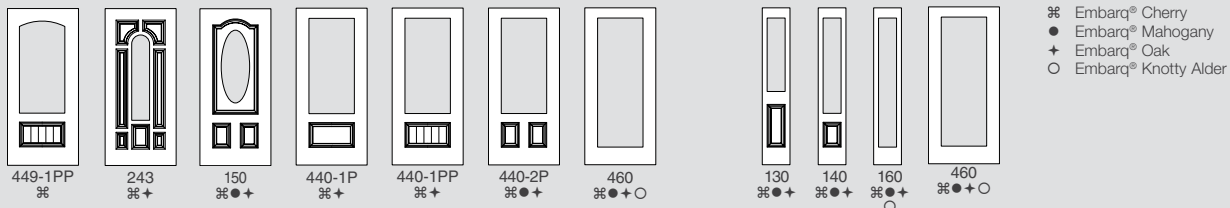

\*Warranty time period may be limited in extreme applications. See warranty for details.

Stiles and rails are dovetailed and glued at each corner creating a structurally solid, integrated frame.



To enhance efficiency and accommodate more insulation, we thickened the door and sidelites from the standard 1 1/4" to 2 1/2" which is **43% thicker** than standard exterior doors. We also engineered a **dual perimeter seal** for the entry door to create a superior barrier against drafts and energy leaks.

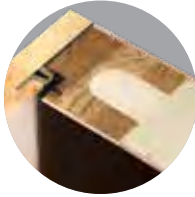

We engineered a channel in the side rails and header of the door to allow for a **larger energy efficient polyurethane core**. Our computer-controlled process fills every crevice with the foam barrier material resulting in **a level of energy efficiency unparalleled in the industry**.

We started from the inside out to maximize energy savings and reduce thermal loss, resulting in the most energy efficient door in the U.S. market. In fact, this door offers at least **4-times more insulating value than a typical wood door** giving an unprecedented U-Factor of 0.09 - the lowest recorded heat conduction measurement for entry doors in the U.S.

**Door edge** is constructed with cherry, mahogany or oak wood matching the selected series.

The **4 1/4" finger-jointed 4-ply hardwood strike stile** provides a solid mounting surface for Emtex® hardware and superior structural integrity.

The **authentic wood look** is made possible by using cutting-edge **NVD** (Nickel Vapor Deposition) technology by MasterGrain™.

**Scientifically formulated compounds** provide superior resistance to denting, splitting, cracking and warping.

The revolutionary **DuraFuse™ Finishing System featuring P³ Fusion** yields unprecedented finish durability.

**Z-AC Threshold with auto-adjusting riser**. Standard with anodized bronze finish.



We **custom-designed a sweep** to accommodate the Embarq door's added thickness. This creates a new breed of thermal barrier to keep out unwanted elements and uncomfortable temperatures.

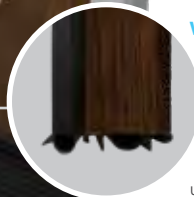



## QUAD GLASS SYSTEM

Our enVision™ innovation and technology has created a revolutionary new design utilizing a Quad Glass System. This glass system is only available for Embarq fiberglass doors and sidelites and utilizes the most energy-efficient glass package available on the market today. This high performance glass system provides an optimal energy efficiency rating.

- A** Low-E Glass Surface
- B** Krypton Filled Air Space
- C** Decorative Glass Core
- D** Super Spacer®
- E** Tri-Seal Spacer
- F** We re-engineered our ComforTech Warm Edge Glazing System to accommodate for the extra panes of glass in this highly efficient package.

## EMBARQ GLASS PACKAGES

ComforTech™ **QLK**  
(Krypton Gas Filled)

●●●●●●●●●●●●●●●●

R-Value of 10

ComforTech™ **QLA**  
(Argon Gas Filled)

●●●●●●●●●●○

R-Value of 9

R-Value reflects properties of the glass only.  
Embarq glass package center of glass calculations.



QLK 1<sup>13</sup>/<sub>16</sub>"  
Insulated Glass Unit

## SKINS AND FINISHES

Embarq doors available in Cherry, Mahogany, Oak and Knotty Alder and feature all the same stain and paint finishes as our Signet® doors shown on pgs. 95-99.

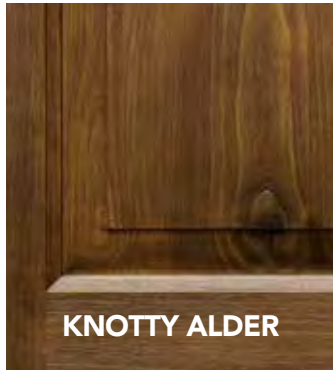
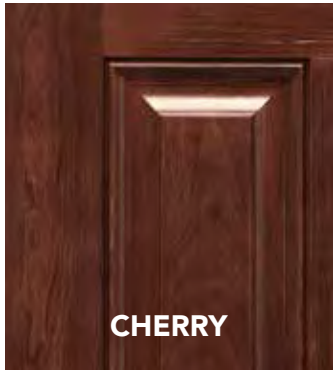

## HARDWARE

Embarq doors are only available with Emtek® hardware. See pg. 108-111 for finish availability.

### EXTERIOR STYLES



Melrose

Orleans

Marietta

Davos

### INTERIOR STYLES (Any interior handle can be used with any exterior handle)



Egg  
(Recommended  
on Melrose)

Egg  
(Recommended  
on Marietta)

Cortina  
(Recommended  
on Orleans)

Stuttgart  
(Recommended  
on Davos)

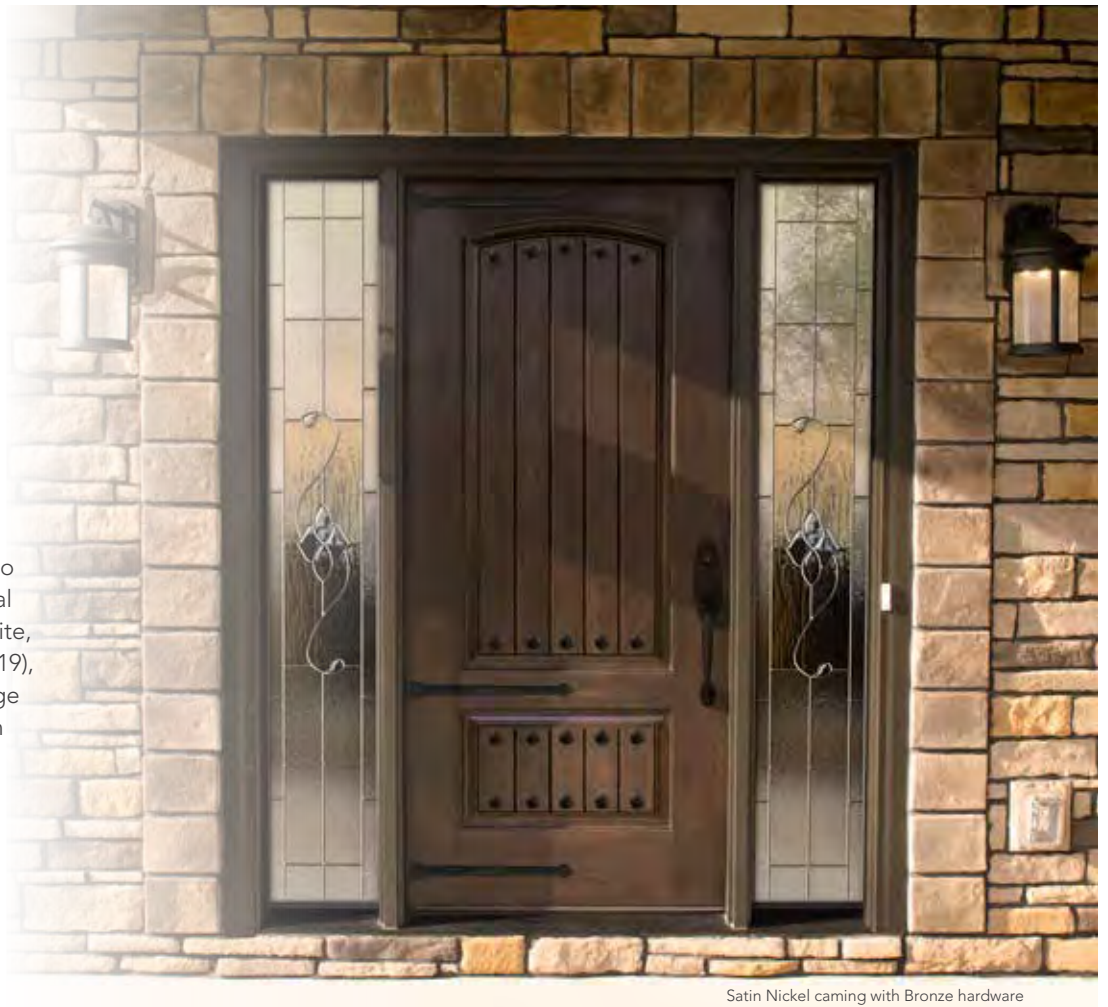

Embarq doors are also available with Colonial Door Knocker, Peepsite, Kick Plate (on page 119), Faux Speakeasy, Hinge Straps and Clavos (on page 120-121).

Satin Nickel casing with Bronze hardware



# SIGNET® FIBERGLASS

## SIGNET SKIN OPTIONS



All fir doors now standard with plugless trim.

Signet Fiberglass doors are available in Cherry, Mahogany, Oak, Fir, Knotty Alder and Smooth Series. Structurally, the Signet door is far superior to traditional fiberglass doors with robust hardwood stiles and rails dovetailed at each corner. All Signet Fiberglass doors exhibit our exclusive DuraFuse™ Finishing System featuring P<sup>3</sup> Fusion, allowing us to offer an industry-best 15-year\* finish warranty.



Most Signet Fiberglass Entry Systems are ENERGY STAR® Certified.

**15-YEAR FINISH WARRANTY\***  
See pgs. 95-99 for paint and stain finishes



### CUSTOMIZE BOTH SIDES

You can customize your entry by ordering a different series, style and finish on each side of your door.



### CUSTOM WIDTHS & HEIGHTS

Need a little more height or a little less width? We offer customized door and sidelite widths and heights in 1/8" increments.

## SIGNET FIBERGLASS DOOR STYLES See pages 30-93 for glass availability.

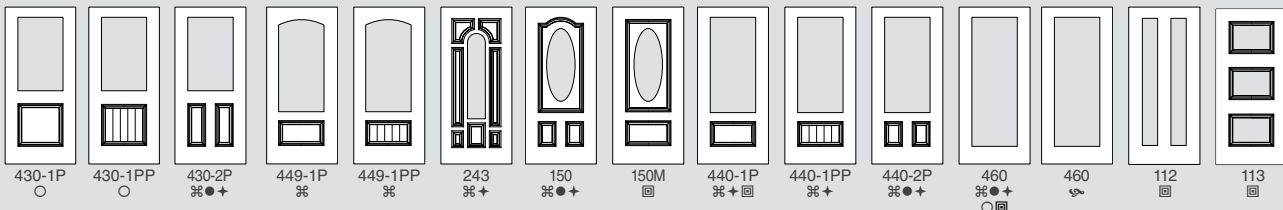
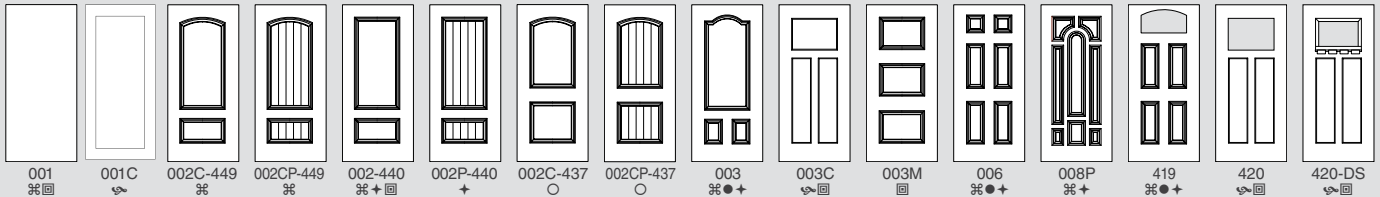

### SIDELITES

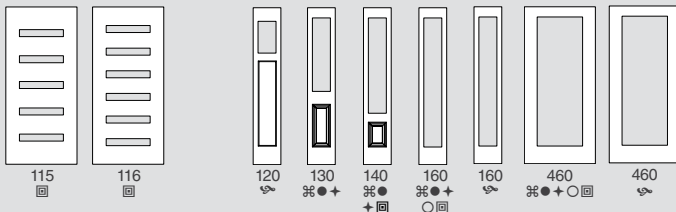

Entry System U-Factor: As low as .16 (Tested to NFRC specifications for a 6 panel door with wood frame).

Note: All Signet doors are shipped finished.

\* Warranty time period may be limited in extreme applications. See warranty for details.

† Patents - USD617005, USD621062, USD621063, USD625837, USD625024

- ☞ Signet Cherry
- Signet Mahogany
- + Signet Oak
- Signet Knotty Alder
- ☞ Signet Fir
- ☐ Signet Smooth

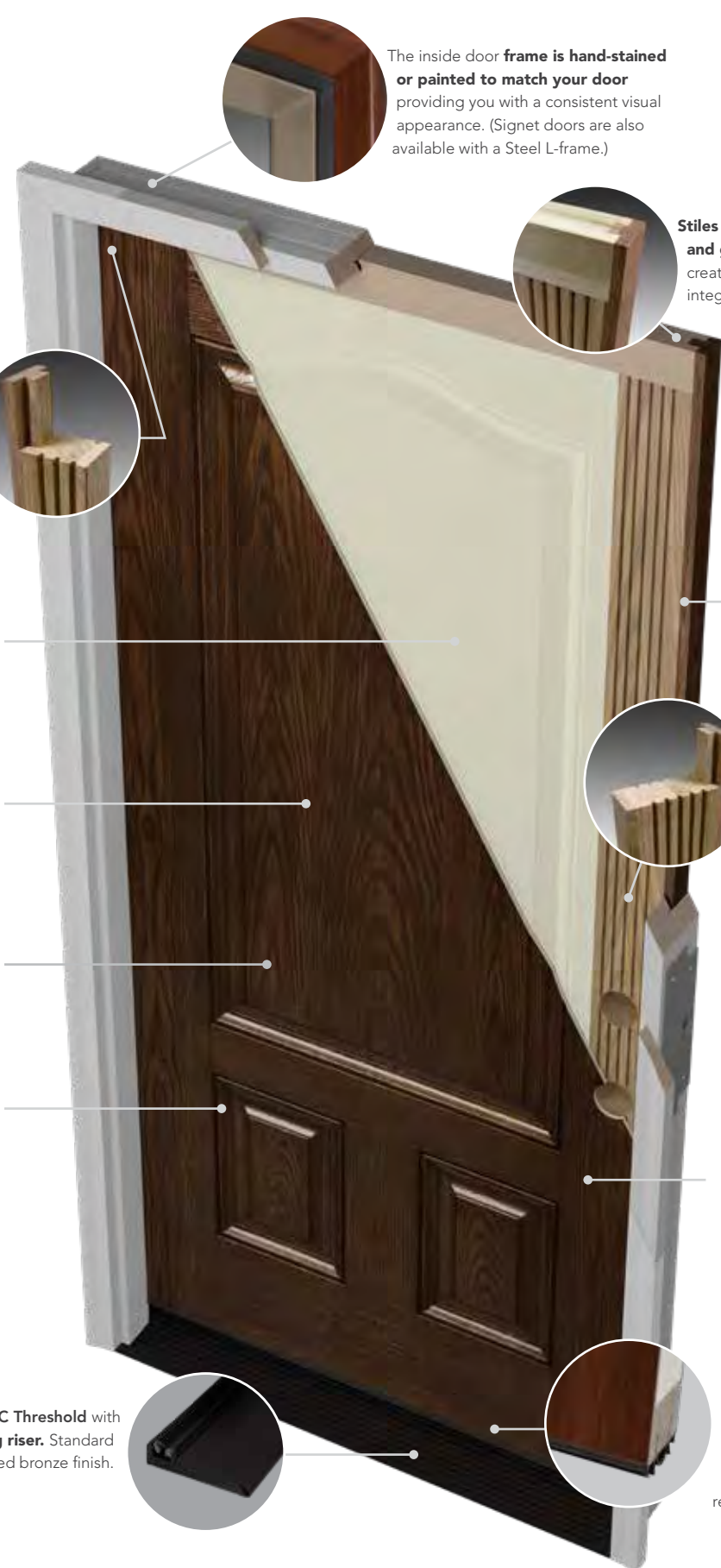

The inside door **frame is hand-stained or painted to match your door** providing you with a consistent visual appearance. (Signet doors are also available with a Steel L-frame.)

**Stiles and rails are dovetailed and glued** at each corner creating a structurally solid, integrated frame.

The **2 1/2" finger-jointed 3-ply hardwood hinge stile** provides superior structural integrity.

Signet doors are **foam filled by a computer driven process** that ensures the optimal foam fill for maximum efficiency and strength.

**Door edge** is constructed with Cherry, Mahogany, Oak or Fir wood matching the selected series.

The **authentic wood look** is made possible by using cutting-edge **NVD** (Nickel Vapor Deposition) technology by MasterGrain™.

The **4 1/4" finger-jointed 4-ply hardwood strike stile** provides a solid mounting surface for decorative hardware and superior structural integrity.

**Scientifically formulated compounds** provide superior resistance to denting, splitting, cracking and warping.

**High-definition panel profile** creates excellent shadow lines and distinct panel designs.

The revolutionary **DuraFuse™ Finishing System featuring P<sup>3</sup> Fusion** yields unprecedented finish durability.

**Plugless Glass Trim** is standard on Signet  
Pat: 9,562,389  
Pat: 9,976,338

**Z-AC Threshold with auto-adjusting riser.** Standard with anodized bronze finish.

A **high-performance, composite material** is utilized on all Signet fiberglass bottom rails, giving excellent rot-resistance.



# HERITAGE™ FIBERGLASS

## HERITAGE SKIN OPTIONS

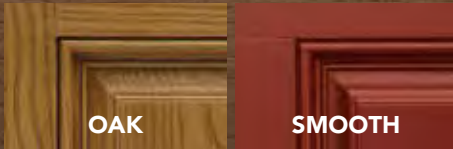

Heritage Fiberglass doors feature enhanced woodgrain texture, improved definition embossing and a hardwood edge to prevent warping.

### 10-YEAR FINISH WARRANTY\*

See pgs. 95-99 for paint and stain finishes



Most Heritage Fiberglass Entry Systems are ENERGY STAR® Certified.



### CUSTOM HEIGHTS

Need a little more or a little less height? We offer customized door and sidelite heights in 1/8" increments.

## HERITAGE FIBERGLASS DOOR STYLES See pages 30-93 for glass availability.

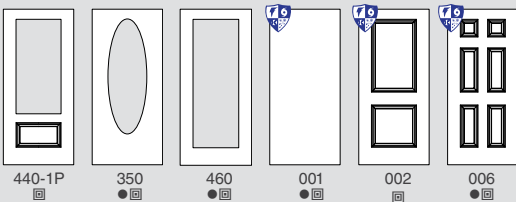
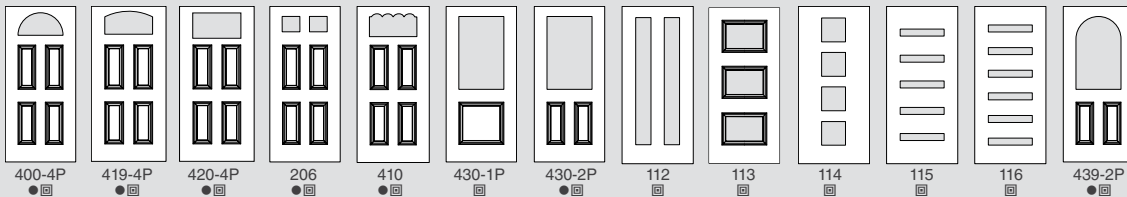

## SIDELITES

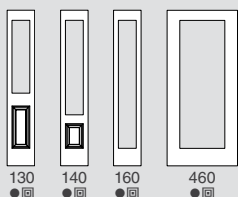

- Oak Grain
- ▣ Smooth Fiberglass

Only Heritage Fiberglass doors without glass are available as an Impact Shield Product.

Entry System U-Factor: As low as .14 (Tested to NFRC specifications for a 6 panel door with wood frame).

\* Warranty time period may be limited in extreme applications. See warranty for details.



**Polyurethane core** reduces energy loss.

**Improved definition panel profile** creates excellent shadow lines and distinct panel designs.

**Specially engineered fiberglass door facings** will not dent and resist splitting, cracking and warping.

**Plugless Glass Trim** is optional on Heritage Fiberglass (see Price List for available styles)

**ZAI™ threshold** has a manually-adjustable riser with complementary screw cover caps. Standard with aluminum mill finish.

**1 1/8" Finger-jointed, 2-ply solid oak laminated stiles** for both hinge and strike sides are proven to provide increased rigidity and structural integrity.

**Variable-depth woodgrain texture with hand-applied stain** imitates a wood door appearance.

**Square-edge design** offers an attractive wood door appearance.

**Lock area is reinforced** to provide a solid mounting surface for decorative hardware.

**A high-performance, composite material** is utilized on all Heritage fiberglass bottom rails, giving excellent rot-resistance.



# LEGACY™ STEEL

## LEGACY SKIN OPTIONS



Legacy Steel features add up to a professional-class product. Whether you select Legacy Woodgrain Textured Steel or Smooth Steel, our entry systems will provide an elegant, durable and energy efficient addition to any home.

**10-YEAR FINISH WARRANTY\***  
See pgs. 95-99 for paint and stain finishes



Most Legacy Steel Entry Systems are ENERGY STAR® Certified.

Legacy Steel Doors with full-lite or half-lite decorative glass with ComforTech™ glazing will include a pane of Low-E glass in order to be ENERGY STAR certified. This includes the following styles; 150, 230, 239, 240, 350, 430, 437, 439 and 460. Since Low-E glass has a slight color tint, it is recommended that sidelites and transoms are ordered with optional Low-E pane to match the door.



**CUSTOMIZE BOTH SIDES**  
You can customize your entry by ordering a different series, style and finish on each side of your door.



**CUSTOM WIDTHS & HEIGHTS**  
Need a little more height or a little less width? We offer customized door and sidelite widths and heights in 1/8" increments.

## LEGACY STEEL DOOR STYLES See pages 30-93 for glass availability.

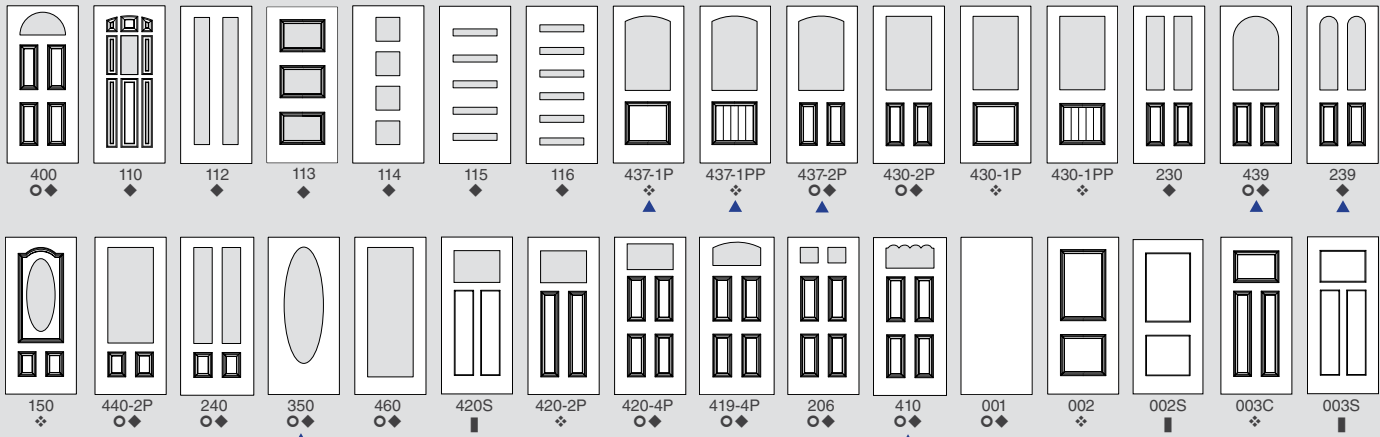

## SIDELITES

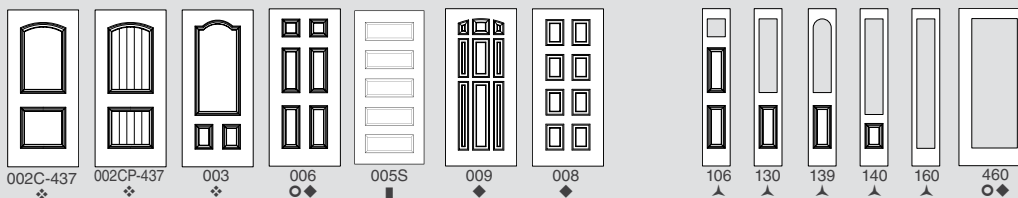

- 20-gauge Woodgrain Textured Steel
- ◆ 20-gauge Smooth Steel
- ❖ 20-gauge Smooth Steel with High-Definition Embossing
- ▲ 24-gauge Smooth or Textured Steel (used with all 20-gauge doors)
- 20-gauge smooth shaker

Entry System U-Factor: As low as .17 (Tested to NFRC specifications for a 6 panel door with wood frame).

\* Warranty time period may be limited in extreme applications. See warranty for details.

† Patent - USD621062

▲ NOT available as an Impact Shield product



Composite top endcaps increase rigidity and energy efficiency.

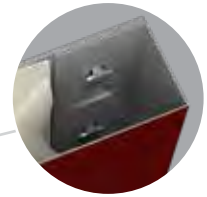

**Special adhesives/thermal barrier** reduce heat and cold transfer, while our exclusive tab and slot system of **mechanical interlocks** gives the door exceptional structural strength.

ProVia doors are **foam filled by a computer driven process** that ensures the optimal foam fill for maximum energy efficiency and strength.

The edges and face skin of our steel doors are **one continuous piece of steel** for strength and durability.

To reinforce the lock and deadbolt area, we add a **rigid composite lock block** to all of our steel doors.

**Plugless Glass Trim** is optional on Legacy Steel (see Price List for available styles)

Our 20-gauge steel doors give you **49% more galvanized steel** than a standard 24-gauge door.



Composite bottom endcaps increase rigidity and energy efficiency.

**Z-AC Threshold** with **auto-adjusting riser**. Standard with aluminum mill finish.





# 8' DOORS

8' Doors provide a majestic first impression. Choose from many available glass and door styles (shown on pgs. 30-93). Trilennium® multi-point hardware offers homeowners better door closure and sealing than a single point lock.

Trilennium or Hoppe multi-point hardware is required on all 8' fiberglass doors. See pages 104-107 for more information on Trilennium and Hoppe hardware.



### SIGNET FIBERGLASS DOOR STYLES

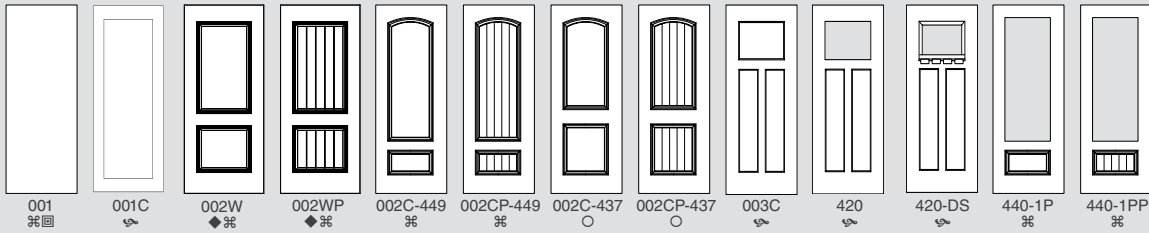

### SIDELITES

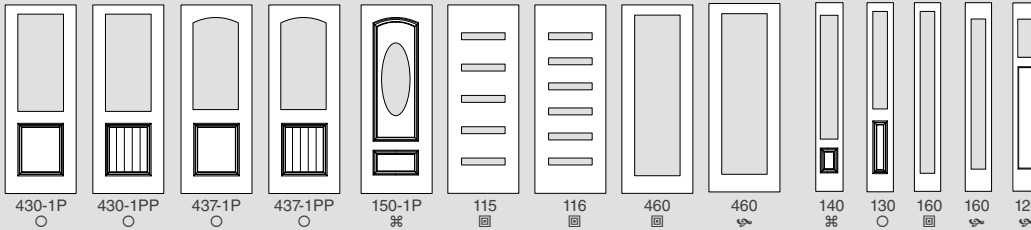

- ⌘ Signet Cherry
- Signet Mahogany
- + Signet Oak
- Signet Knotty Alder
- ⤵ Signet Fir
- ◻ Signet Smooth
- ◆ Only available in 42" x 96" size

Entry System U-Factor: As low as .16 (Tested to NFRC specifications for a 6 panel door with wood frame).  
 Note: All Signet doors are shipped finished.

\* Warranty time period may be limited in extreme applications. See warranty for details.  
 † Patents - USD617005, USD621062, USD621063, USD625837, USD625024

### HERITAGE FIBERGLASS DOOR STYLES

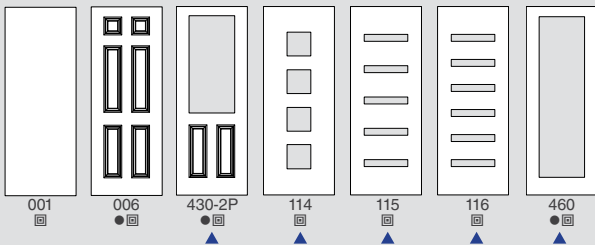

### SIDELITES



- Oak Grain
- ◻ Smooth Fiberglass

Entry System U-Factor: As low as .14 (Tested to NFRC specifications for a 6 panel door with wood frame).  
 \* Warranty time period may be limited in extreme applications. See warranty for details.

### LEGACY STEEL DOOR STYLES

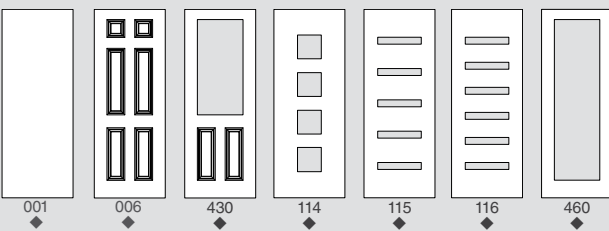

### SIDELITES

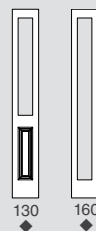

- 20-gauge Woodgrain Textured Steel
- ◆ 20-gauge Smooth Steel
- ❖ 20-gauge Smooth Steel with High-Definition Embossing
- ▲ 24-gauge Smooth or Textured Steel (used with all 20-gauge doors)

Entry System U-Factor: As low as .17 (Tested to NFRC specifications for a 6 panel door with wood frame).  
 \* Warranty time period may be limited in extreme applications. See warranty for details.  
 † Patent - USD621062

▲ NOT available as an Impact Shield product



# FRENCH DOORS

French doors make an elegant statement like nothing else. Express your personality by creating a simple yet striking entry. Make it as ornate and beautiful as you like.



## FRENCH DOOR DETAILS

- All door styles are available as a French Door
- Available with FrameSaver® or Steel L-Frame
- Hinged on each end with door knobs in the center
- Available with either left or right active door (main entryway)
- Center astragal is attached to the inactive door and includes top and bottom slide bolts (used to open inactive door)
- Available as inswing or outswing
- Header security plate standard on frame
- Hardware Installation: locksets, deadbolts and kickplates will be installed on active and inactive doors, all other hardware on active door only
- Also available with Trilennium hardware

## ASTRAGAL DETAILS

The French Door Astragal provides functionality and security

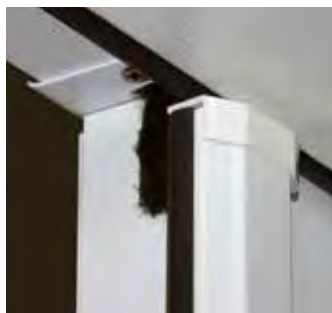

Astragal secures inactive door at top and bottom of your french door system



Lockable throw bolts improve security

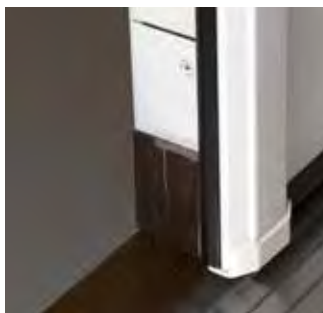

Astragal bolt penetrates threshold allowing boot to seal, creating a better barrier against the elements



Astragal is stained to match Signet Fiberglass stained doors.

## STYLES/CONFIGURATIONS

All door styles are available as a French Door.  
(See pages 10-21 for [Impact Shield](#) & [Windload](#) availability)

Custom size clear glass transom

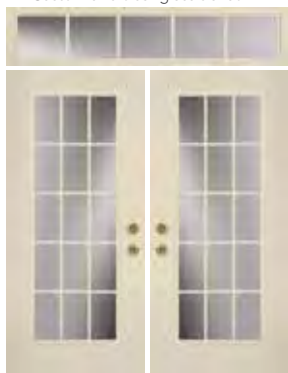

460DC-IGT 460DC-IGT



160SYA 460SYA 460SYA 160SYA



460LAU 460LAU

⚠ Cannot be mulled with Heritage Fiberglass doors in Certified Wind Load regions



## UNEQUAL FRENCH DOORS

You now have the ability to utilize the larger entry door day-to-day, yet have the option to open the smaller, inactive door to gain full access.

Available in smooth steel only. Internal blind sizes are limited. See Price List for details.



345

# INSCRIBED DOORS

Elegant and refined to complement an entrance way. Each design is engraved into a Signet® Cherry fiberglass panel showcasing true richness of color and sophistication. Also available with three stainless steel inlay models.

## INSCRIBED STYLES (Only available in flush Signet cherry doors.)



001-INS3C



001-INS3-HN



001-INS6



001-INS5

## STAINLESS STEEL INLAY STYLES (Only available in flush Signet cherry doors.)



001-INL4



001-INL4S



001-INL6

## AVAILABLE COLORS

### CHERRY STAINS

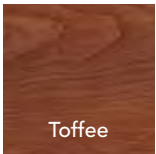

Toffee

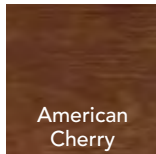

American  
Cherry

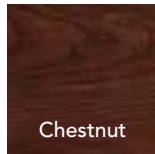

Chestnut

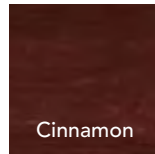

Cinnamon

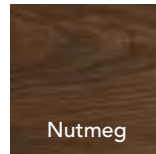

Nutmeg

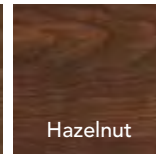

Hazelnut

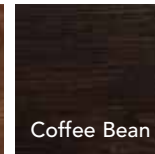

Coffee Bean

### 15-YEAR FINISH WARRANTY\*

Embarq and Signet Fiberglass

\*Warranty time period may be limited in extreme exposure applications. See warranty for details.



# DOORS WITHOUT GLASS

Doors Without Glass will fill your needs beautifully when privacy is needed.

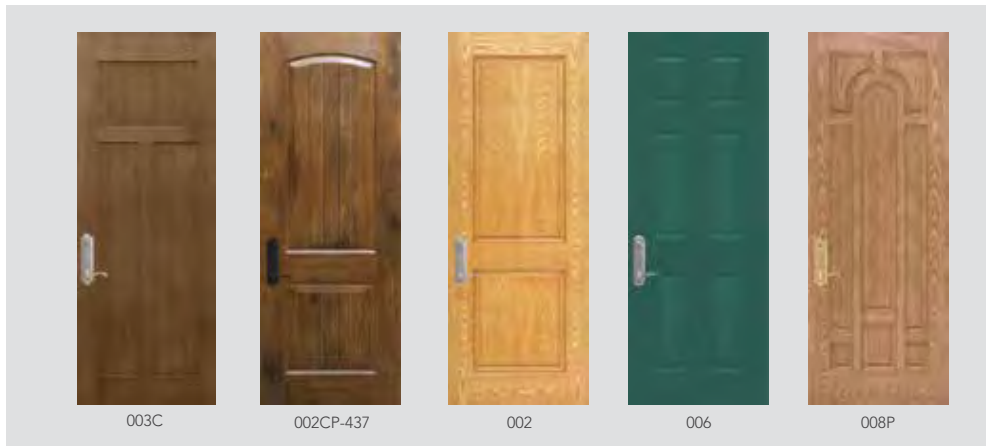
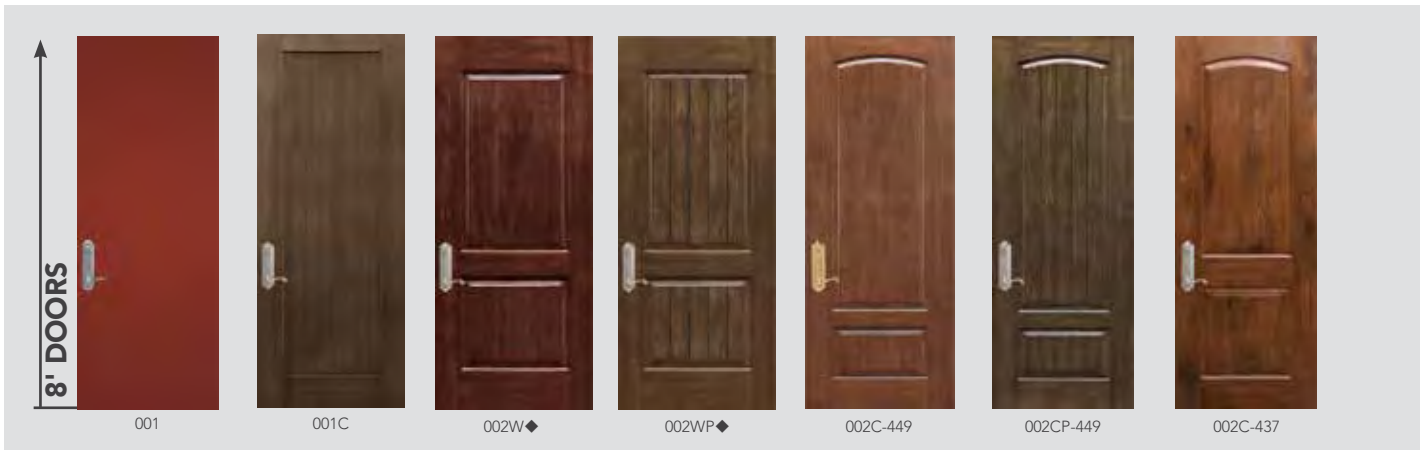



**DOORS WITHOUT GLASS** STYLE AVAILABILITY (See pages 10-21 for **Impact Shield** & **Windload** availability)

	Doors																
	009	008P	008	006	004	005	003M	003	003C	002S	002C(P)-449	002	002C(P)-437	002-440	002P-440	001C	001
Embarq / Signet Mahogany Series				•				•									
Embarq / Signet Cherry Series	•		•					•		•				•			•
Embarq / Signet Oak Series	•		•					•						•	•		
Signet Fir Series									•							•	•
Embarq / Signet Knotty Alder Series													•				
Signet Smooth Series							•							•			•
Heritage Woodgrain Textured Fiberglass			•	•				•				•					•
Heritage Smooth Fiberglass			•	•				•				•					•
20-Gauge Woodgrain Textured Steel			•														•
20-Gauge Smooth Steel	•	•	•		•			•	•	•		•	•				•

	8' Doors								
	001	001C	002W(P)	002C(P)-449	002C(P)-437	002	003S	006	008P
Embarq / Signet Cherry Series	*		*		*				
Signet Fir Series		•							•
Embarq / Signet Knotty Alder Series					*				
Signet Smooth Series	•								
Heritage Woodgrain Textured Fiberglass						•		•	•
Heritage Smooth Fiberglass	•							•	
20-Gauge Smooth Steel	•							•	

\* Embarq doors and sidelites are not available in 8' heights

◆ Only available in 42" x 96" size



All Entry Systems Without Glass are ENERGY STAR® Certified.



# COMFORTECH™

**LIFETIME LIMITED WARRANTY**  
Includes Glass Breakage and Seal Failure

Measurably improve thermal performance with the ComforTech™ Warm Edge Glazing System. You'll enjoy better energy efficiency and a warmer glass edge.

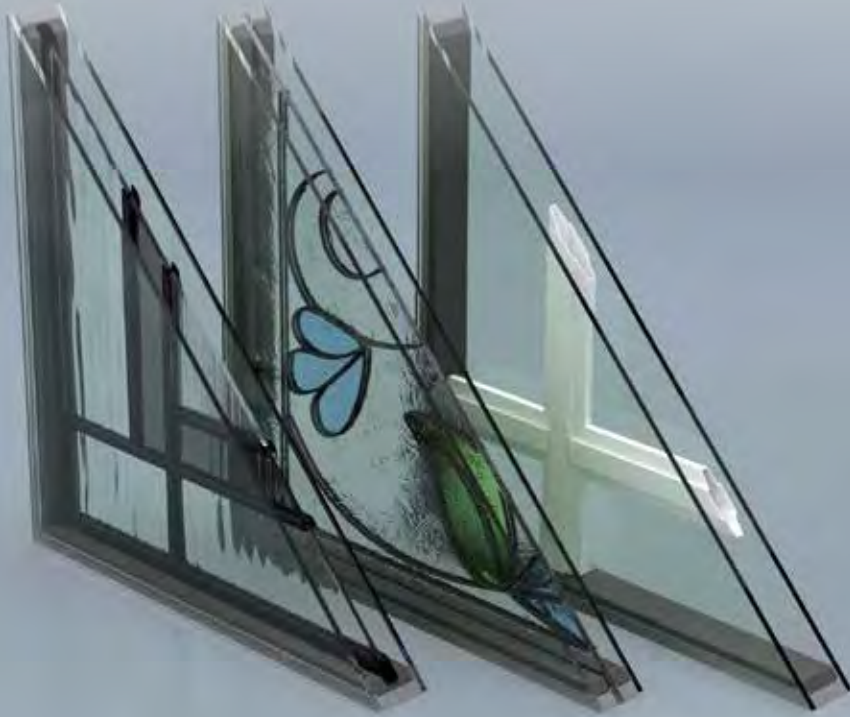

## COMFORTECH ADVANTAGES



The NO-Metal Advantage

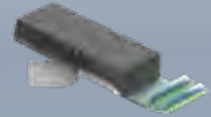

Mylar 10-Layer Vapor Barrier



Withstands Normal Bowing



Enhanced Noise Reduction

## COMFORTECH WARM EDGE GLAZING SYSTEM IS INCLUDED IN ALL:

- Decorative Glass
- Inspirations™ Art Glass
- Privacy Glass
- Clear Glass
- Grids (Internal, External and SDL)

## GLAZING SYSTEM OPTIONS

ComforTech™ TLK  
ComforTech™ TLK-UV

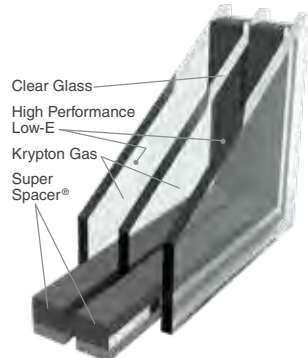

R-Value of 10

ComforTech™ TLA  
ComforTech™ TLA-UV

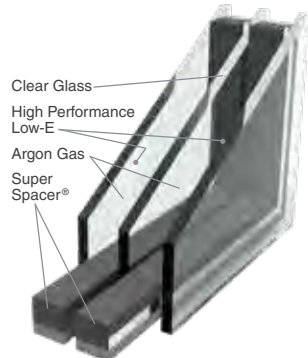

R-Value of 7

ComforTech™ DLA  
ComforTech™ DLA-UV

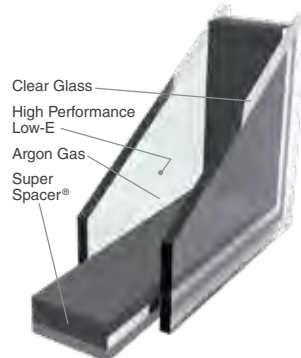

R-Value of 4

ComforTech™ DC



R-Value of 2

R-Value reflects properties of the glass only. Center of glass calculations are based upon software from Lawrence Berkeley National Laboratory.

## ELEVATION SERIES

for customers in high altitude areas

Insulated glass without Argon or Krypton. Capillary tubes are open and inserted behind glazing bead. Low-E softcoat and hardcoat available for vinyl patio doors.

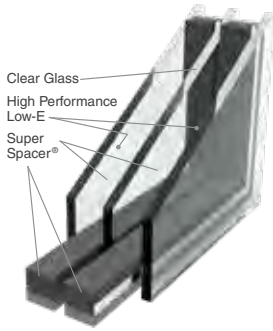

ComforTech™ **TLE**  
ComforTech™ **TLE-UV**



ComforTech™ **DLE**  
ComforTech™ **DLE-UV**

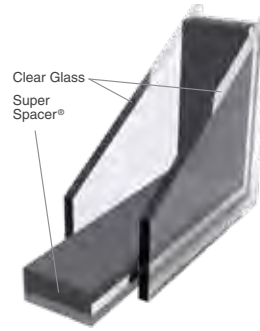

ComforTech™ **DE**



## Understanding the Acronyms

- T** - Triple Glazed
- D** - Double Glazed
- L** - Low E
- C** - Clear
- A** - Argon
- K** - Krypton
- E** - Elevation (no gas)
- UV** - Ultraviolet
- HC** - Hard Coat

Some Elevation Series (TLE-UV, TLE, DLE-UV and DLE) glass offerings require a hardcoat option to be ENERGY STAR® compliant.

## IMPACT SHIELD

All Impact Shield products feature ComforTech™ laminated glass.

ComforTech™ **TLK-C**  
ComforTech™ **TLK-UV-C**

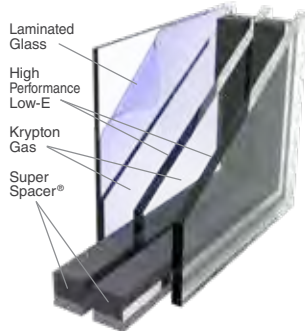

ComforTech™ **TLA-C**  
ComforTech™ **TLA-UV-C**

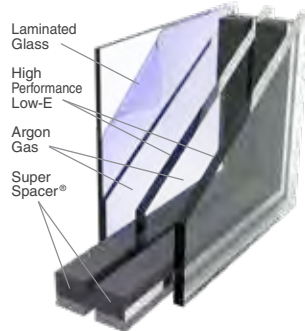

ComforTech™ **DLA-C**  
ComforTech™ **DLA-UV-C**

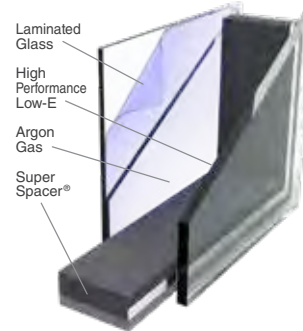

ComforTech™ **DC-C**

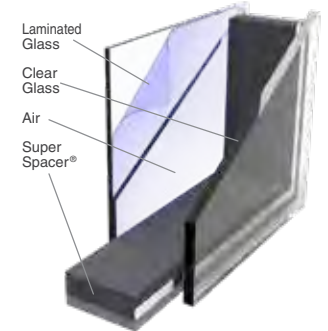

R-Value reflects properties of the glass only. Center of glass calculations are based upon software from Lawrence Berkeley National Laboratory.

## FLORIDA

Impact Shield products are designed to protect your family and home against the harshest storms and deter burglars. All entry systems and patio doors in this Impact Shield products section are wind-borne debris resistant and approved by the state of Florida. [floridabuilding.org](http://floridabuilding.org)

- Impact Shield
- Certified Wind Load
- High-Velocity Hurricane Zones  
(ProVia products have not been tested for use in High-Velocity Hurricane Zones)





# DECORATIVE GLASS



Highly-skilled craftsmen assemble hand-beveled glass accented with a variety of unique glass options by precisely cutting, mitering and soldering each component into artistically designed patterns.

Decorative glass purposefully seeks visual character through aesthetic imperfections, while maintaining structural stability. These "imperfections" mimic the hand-made sheet glass of centuries past. They come in the form of textural waves and striations, random seeds (air bubbles) and a variety of other natural effects.

Decorative glass achieves its personality through these apparent flaws and no two sheets are ever identical. Each glass panel is hand-made and reflects minor differences from piece to piece. This is characteristic of any hand-made product and adds to the charm and beauty of the product.

We continually inspect for consistency. The patterns can vary in size and particular shapes, but pose no danger of spontaneous breakage or structural instability. Any patterns that are severely out of character with the glass are not accepted. Our goal is to provide the finest quality glass panels.

## ALL DECORATIVE GLASS:

### 1. ProVia Exclusive

These decorative glass designs are only found on ProVia doors. This gives your entryway a unique style that can't be found anywhere else.

### 2. Includes ComforTech™ Warm Edge Glazing System

Measurably improve thermal performance with our ComforTech Warm Edge Glazing System. You'll enjoy better energy efficiency and a warmer glass edge.

### 3. Impact Shield available

Impact Shield Products are designed to protect your family and home against the harshest storms and help deter burglaries. Impact Shield products feature laminated glass and can withstand repeated blows from wind-borne debris or unwanted intruders.

### 4. Covered by a Lifetime Limited Warranty

Warranty includes glass breakage and seal failure.







Each piece of glass is meticulously cleaned and inspected for consistency.





Narrow/Thin Reed

Clear Beveled

Caming



# MIRAGE

DECORATIVE GLASS

Mirage offers effortless style, with narrow/thin reed glass all over, complemented by clear beveled glass. Zinc caming tops it off, making it a simple, modern and attractive design.

## CAMING FINISH

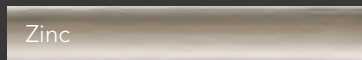

## PRIVACY RATING

1 2 3 4 5 6 **7** 8 9 10

less privacy more privacy

**LIFETIME LIMITED WARRANTY**  
Includes Glass Breakage & Seal Failure



All full wood frame and composite frame entry systems using Mirage Glass are ENERGY STAR® Certified and some steel L-Frame entry systems using Mirage Glass are ENERGY STAR Certified. See the ENERGY STAR section of our website for energy ratings on specific styles.

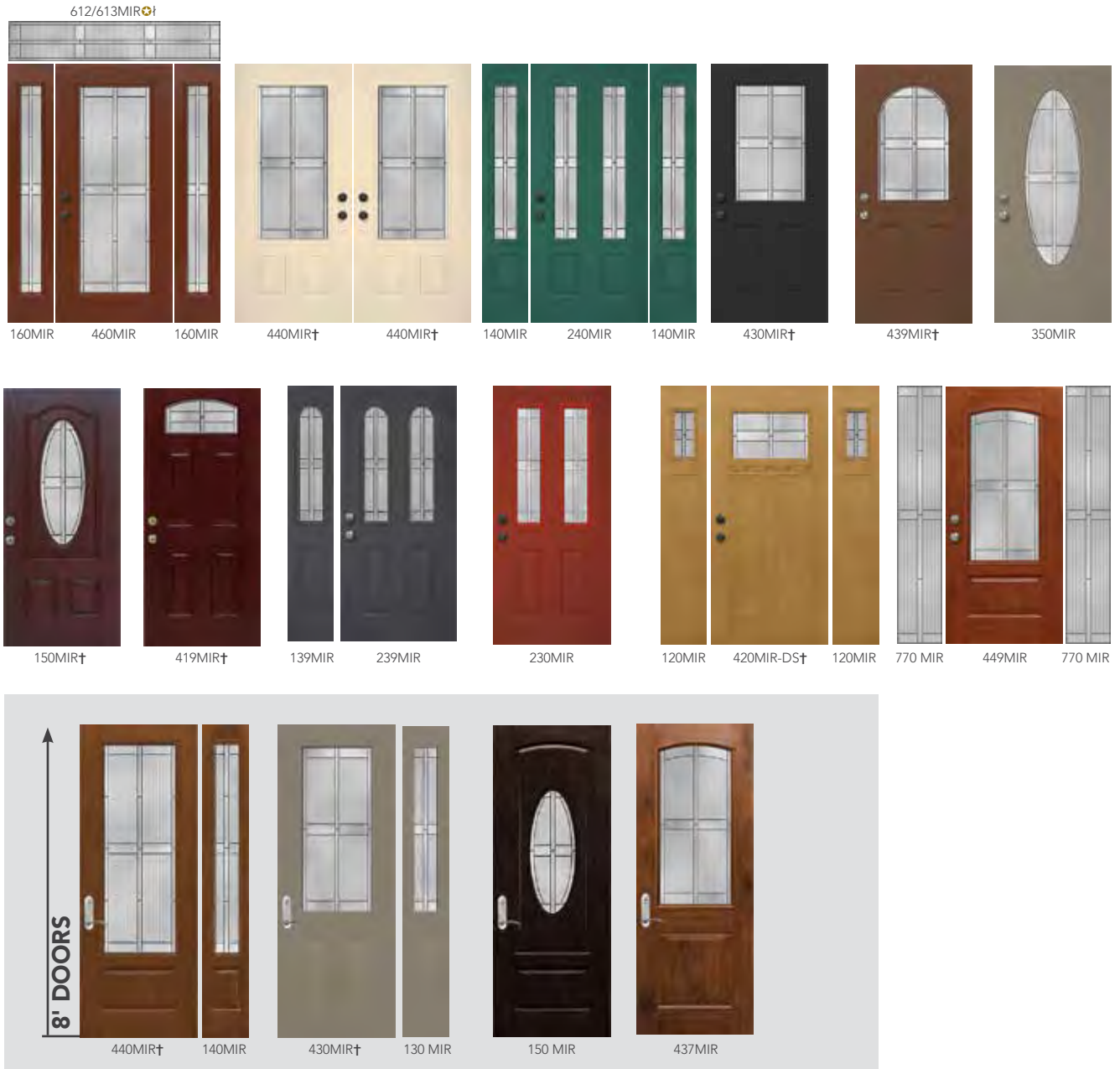

† For additional door panel styles see pg. 10 (for Embarq®), pg. 14 (for Signet®), pg. 16 (for Heritage™) or pg. 18 (for Legacy™)

‡ Requires an additional 6-week lead time

⊛ Cannot be mulled with Heritage Fiberglass doors in Certified Wind Load regions



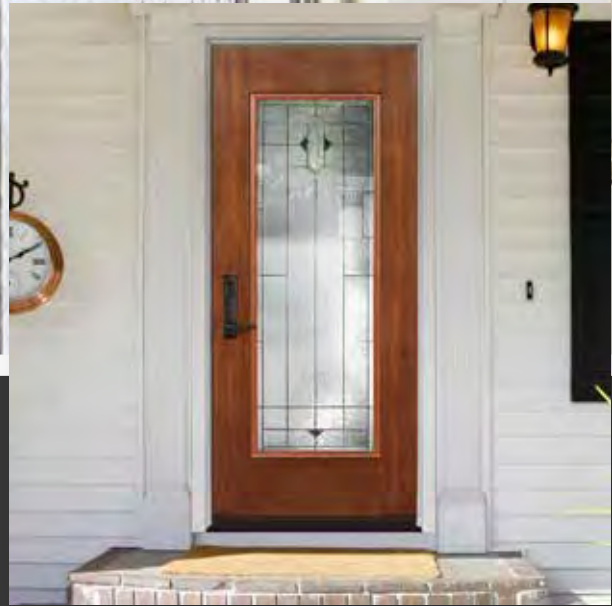

# BROOKHAVEN

## DECORATIVE GLASS

Brookhaven is accented with gray antique glass, giving it a subtle hint of color. The hammered glass delivers some privacy and is accentuated with clear beveled and microcubed glass throughout.

### CAMING FINISH

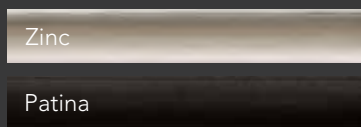

Specify caming finish using these codes:  
Zinc - BRZ, Patina - BRP

### PRIVACY RATING

1 2 3 4 5 6 7 **8** 9 10

less privacy

more privacy

### LIFETIME LIMITED WARRANTY

Includes Glass Breakage & Seal Failure



All full wood frame and composite frame entry systems using Brookhaven Glass are ENERGY STAR® Certified and some steel L-Frame entry systems using Brookhaven Glass are ENERGY STAR Certified. See the ENERGY STAR section of our website for energy ratings on specific styles.



612/613BRO



160BRO 460BRO 160BRO



140BRO 440BRO† 140BRO



449BRO



350BRO



150BRO†



240BRO



243BRO



130BRO 430BRO†



439BRO †



230BRO



139BRO 239BRO

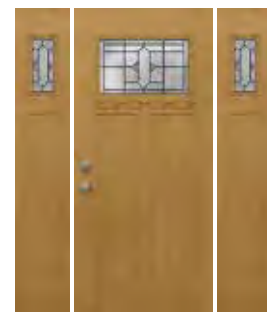

120BRO 420BRO-DS 120BRO



419BRO†

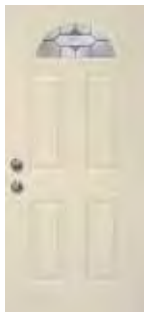

400BRO†



8' DOORS

440BRO†

140BRO

430BRO†

130BRO

437BRO†

150BRO

Brookhaven Glass

§ Also available in 10" width (which requires an additional 4-week lead time). See Price List for design pattern  
† Requires an additional 6-week lead time

† For additional door panel styles see pg. 10 (for Embarq®), pg. 14 (for Signet®), pg. 16 (for Heritage™) or pg. 18 (for Legacy™)  
⊕ Cannot be mullied with Heritage Fiberglass doors in Certified Wind Load regions





Streamed

Caming

Clear Beveled

Gray Softwave



# MANHATTAN

## DECORATIVE GLASS

Manhattan features streamed glass, clear bevels and gray softwave, combining simplicity and modern style. Accent it with either patina or zinc caming to customize the look.

### CAMING FINISH

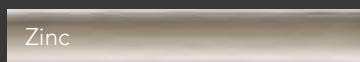

Zinc

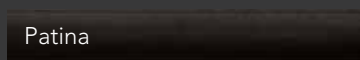

Patina

Specify caming finish using these codes:  
Zinc - MAZ, Patina - MAP

### PRIVACY RATING

1 2 3 4 5 6 7 **8** 9 10

less privacy

more privacy

### LIFETIME LIMITED WARRANTY

Includes Glass Breakage & Seal Failure



All full wood frame and composite frame entry systems using Manhattan Glass are ENERGY STAR® Certified and some steel L-Frame entry systems using Manhattan Glass are ENERGY STAR Certified. See the ENERGY STAR section of our website for energy ratings on specific styles.

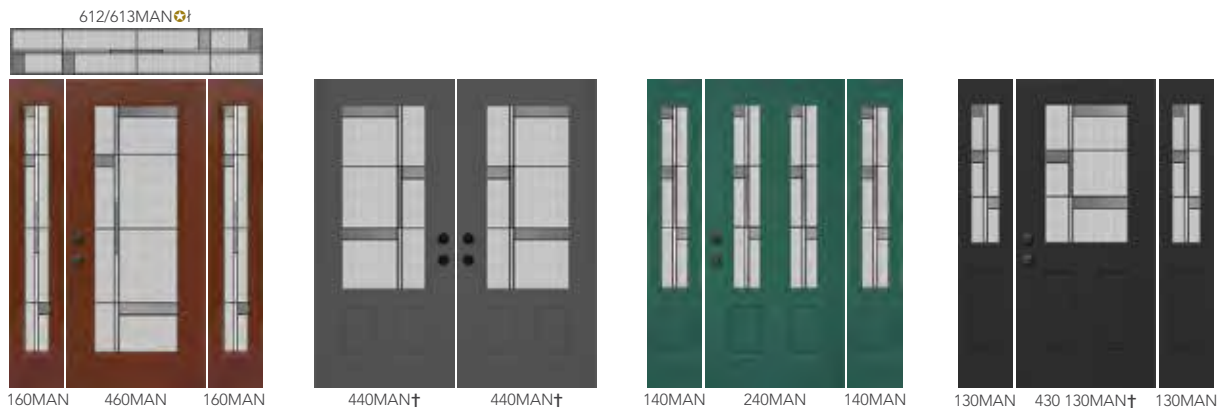

† For additional door panel styles see pg. 10 (for Embarq®), pg. 14 (for Signet®), pg. 16 (for Heritage™) or pg. 18 (for Legacy™)  
 ‡ Requires an additional 6-week lead time  
 ☼ Cannot be mulled with Heritage Fiberglass doors in Certified Wind Load regions





# ESSENCE

## DECORATIVE GLASS

Essence features a bronze softwave glass combined with micro-granite that brings elegance to a whole new level.

### CAMING FINISH

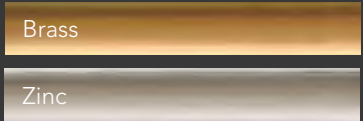

Specify caming finish using these codes:  
Brass - ESB, Zinc - ESZ

### PRIVACY RATING

1 2 3 4 5 **6** 7 8 9 10

less privacy more privacy

### LIFETIME LIMITED WARRANTY

Includes Glass Breakage & Seal Failure



All full wood frame and composite frame entry systems using Essence Glass are ENERGY STAR® Certified and some steel L-Frame entry systems using Essence Glass are ENERGY STAR Certified. See the ENERGY STAR section of our website for energy ratings on specific styles.

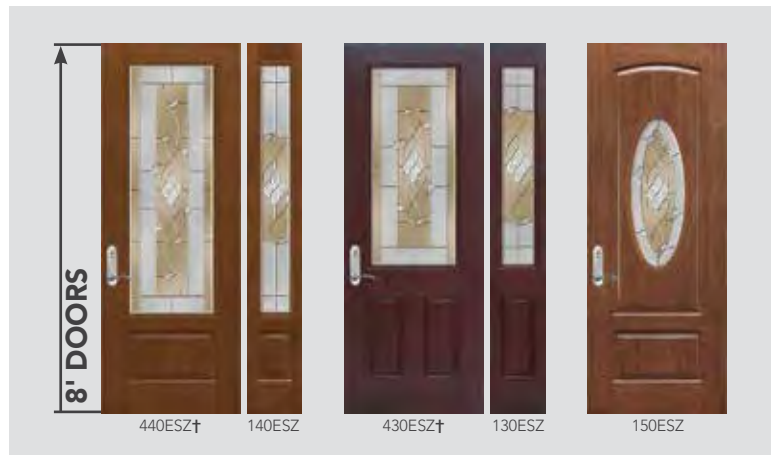

Essence Glass

† For additional door panel styles see pg. 10 (for Embarq®), pg. 14 (for Signet®), pg. 16 (for Heritage™) or pg. 18 (for Legacy™)  
 § Also available in 10" width (which requires an additional 4-week lead time). See Price List for design pattern  
 ‡ Requires an additional 6-week lead time  
 ⚡ Cannot be mulled with Heritage Fiberglass doors in Certified Wind Load regions





# CHEYENNE

## DECORATIVE GLASS

Cheyenne features micro-granite, hammered and beveled glass that will add elegance to your entryway, while providing a high level of privacy.

### CAMING FINISH



Specify caming finish using these codes:  
Patina - CHP, Zinc - CHZ



### PRIVACY RATING

1 2 3 4 5 6 7 **8** 9 10

less privacy

more privacy

### LIFETIME LIMITED WARRANTY

Includes Glass Breakage & Seal Failure



All full wood frame and composite frame entry systems using Cheyenne Glass are ENERGY STAR® Certified and some steel L-Frame entry systems using Cheyenne Glass are ENERGY STAR Certified. See the ENERGY STAR section of our website for energy ratings on specific styles.

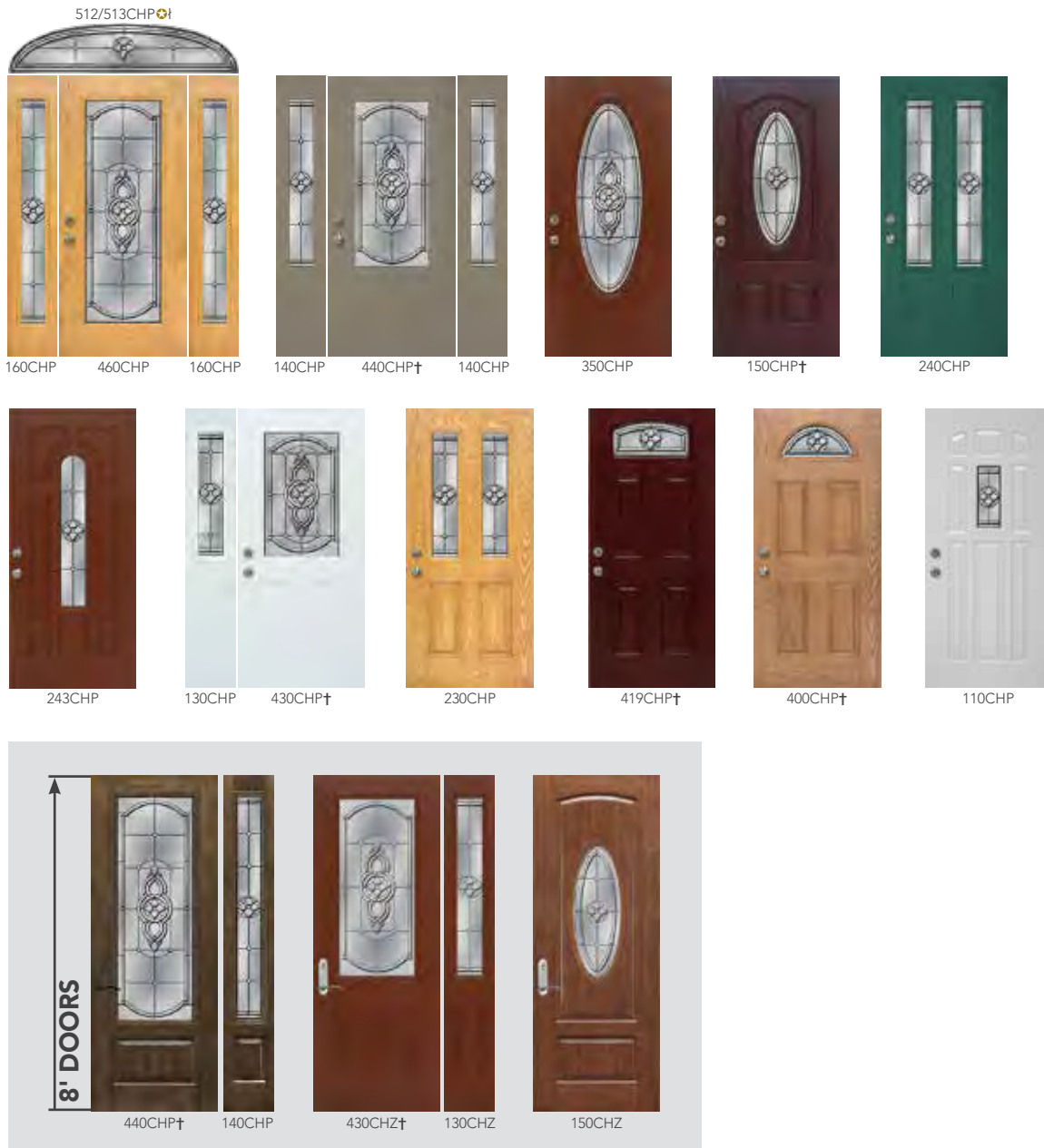

Cheyenne Glass

† For additional door panel styles see pg. 10 (for Embarq®), pg. 14 (for Signet®), pg. 16 (for Heritage™) or pg. 18 (for Legacy™)  
 ‡ Requires an additional 6-week lead time  
 ✎ Cannot be mulled with Heritage Fiberglass doors in Certified Wind Load regions





# SYMPHONY

## DECORATIVE GLASS

Symphony features a bronze softwave and expresses timeless beauty and elegance at every curve. This design is sure to bring you a pleasing and melodious style.

### CAMING FINISH



Specify caming finish using these codes:  
Brass - SYB, Patina - SYP, Zinc - SYZ

### PRIVACY RATING

1 2 3 4 **5** 6 7 8 9 10

less privacy

more privacy

### LIFETIME LIMITED WARRANTY

Includes Glass Breakage & Seal Failure



All full wood frame and composite frame entry systems using Symphony Glass are ENERGY STAR® Certified and some steel L-Frame entry systems using Symphony Glass are ENERGY STAR Certified. See the ENERGY STAR section of our website for energy ratings on specific styles.



160SYA 460SYA 160SYA 140SYA 440SYA † 140SYA 160SYA 350SYA 160SYA 770SYA † § 449SYA † 770SYA † § † 150SYA †



240SYA 243SYA 130SYA 430SYA † 230SYA 120SYA 420SYA-DS 120SYA 419SYA † 400SYA †



460SYA 160SYA 440SYA † 140SYA 430SYA † 130SYA 437SYA † 150SYA

Symphony Glass

§ Also available in 10" width (which requires an additional 4-week lead time). See Price List for design pattern  
 † Requires an additional 6-week lead time

‡ For additional door panel styles see pg. 10 (for Embarq®), pg. 14 (for Signet®), pg. 16 (for Heritage™) or pg. 18 (for Legacy™)  
 † Cannot be mullied with Heritage Fiberglass doors in Certified Wind Load regions  
 \* In Certified Wind Load region, indicated transoms must be installed in a separate opening or use approved engineering mulls





Small Hammered

Caming

Clear Beveled

Micro-iced Granite



# BERKLEY

## DECORATIVE GLASS

Berkley features micro-iced granite, clear bevels, and small hammered with a timeless herringbone pattern that complements modern, contemporary and Arts & Crafts architecture.

### CAMING FINISH

- Antique Brass
- Zinc
- Patina

Specify caming finish using these codes:  
 Antique Brass - BEA, Zinc - BEZ,  
 Patina - BEP

### PRIVACY RATING

1 2 3 4 5 6 **7** 8 9 10

less privacy more privacy

### LIFETIME LIMITED WARRANTY

Includes Glass Breakage & Seal Failure



All full wood frame and composite frame entry systems using Berkley Glass are ENERGY STAR® Certified and some steel L-Frame entry systems using Berkley Glass are ENERGY STAR Certified. See the ENERGY STAR section of our website for energy ratings on specific styles.

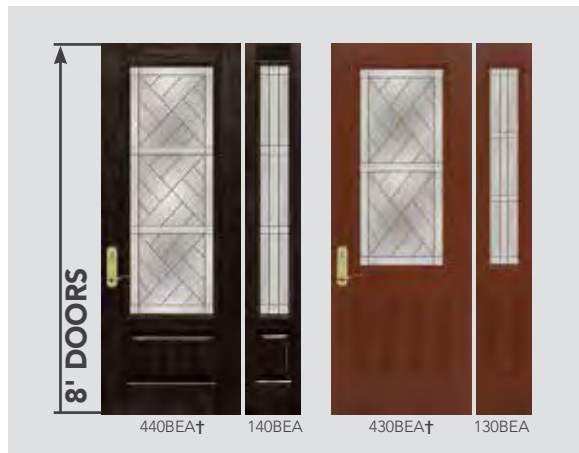
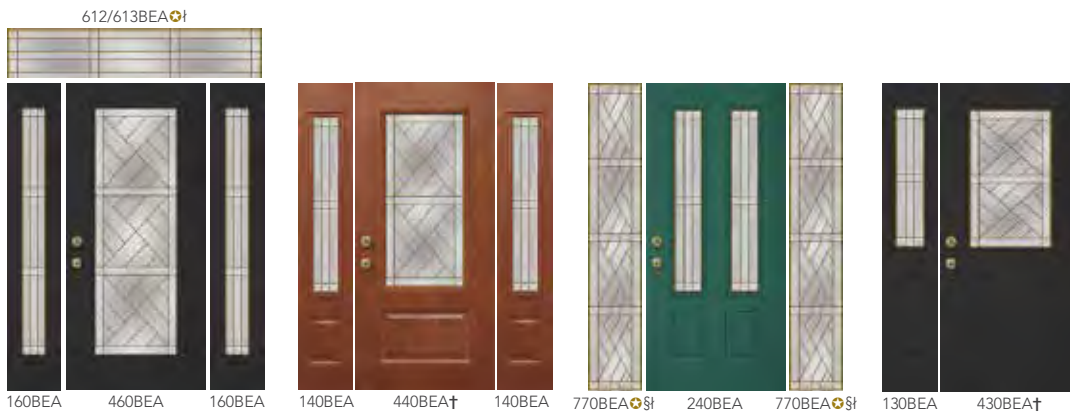

§ Also available in 10" width (which requires an additional 4-week lead time). See Price List for design pattern  
 † Requires an additional 6-week lead time

‡ For additional door panel styles see pg. 10 (for Embarq®), pg. 14 (for Signet®), pg. 16 (for Heritage™) or pg. 18 (for Legacy™)  
 ‡ Cannot be mulled with Heritage Fiberglass doors in Certified Wind Load regions





# LAURENCE

## DECORATIVE GLASS

Laurence features a gray softwave expressing defined classical vintage that will greet your guests with its distinguished character and prominent lines.

### CAMING FINISH

Patina

### PRIVACY RATING

1 2 3 4 5 **6** 7 8 9 10

less privacy

more privacy

### LIFETIME LIMITED WARRANTY

Includes Glass Breakage & Seal Failure



All full wood frame and composite frame entry systems using Laurence Glass are ENERGY STAR® Certified and some steel L-Frame entry systems using Laurence Glass are ENERGY STAR Certified. See the ENERGY STAR section of our website for energy ratings on specific styles.

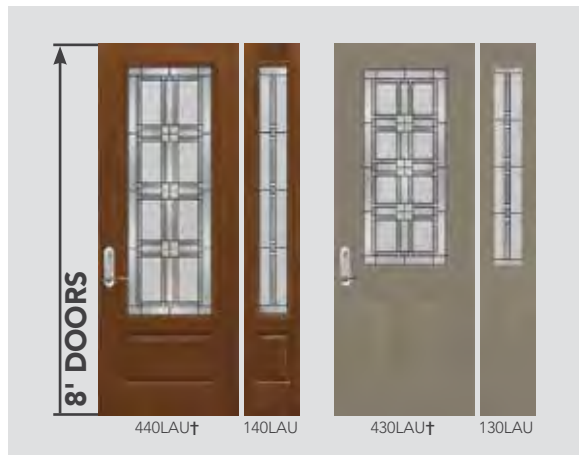

† For additional door panel styles see pg. 10 (for Embarq®), pg. 14 (for Signet®), pg. 16 (for Heritage™) or pg. 18 (for Legacy™)  
 ‡ Requires an additional 6-week lead time  
 ☼ Cannot be mulled with Heritage Fiberglass doors in Certified Wind Load regions





# CARRINGTON

## DECORATIVE GLASS

Carrington features small hammered, flat seedy and clear bevels in an attractive vintage design to accent your home's entryway.

### CAMING FINISH

Patina



### PRIVACY RATING

1 2 3 4 **5** 6 7 8 9 10

less privacy

more privacy

### LIFETIME LIMITED WARRANTY

Includes Glass Breakage & Seal Failure



All full wood frame and composite frame entry systems using Carrington Glass are ENERGY STAR® Certified and some steel L-Frame entry systems using Carrington Glass are ENERGY STAR Certified. See the ENERGY STAR section of our website for energy ratings on specific styles.



Carrington Glass

§ Also available in 10" width (which requires an additional 4-week lead time). See Price List for design pattern  
 † Requires an additional 6-week lead time

† For additional door panel styles see pg. 10 (for Embarq®), pg. 14 (for Signet®), pg. 16 (for Heritage™) or pg. 18 (for Legacy™)  
 ✪ Cannot be mulled with Heritage Fiberglass doors in Certified Wind Load regions



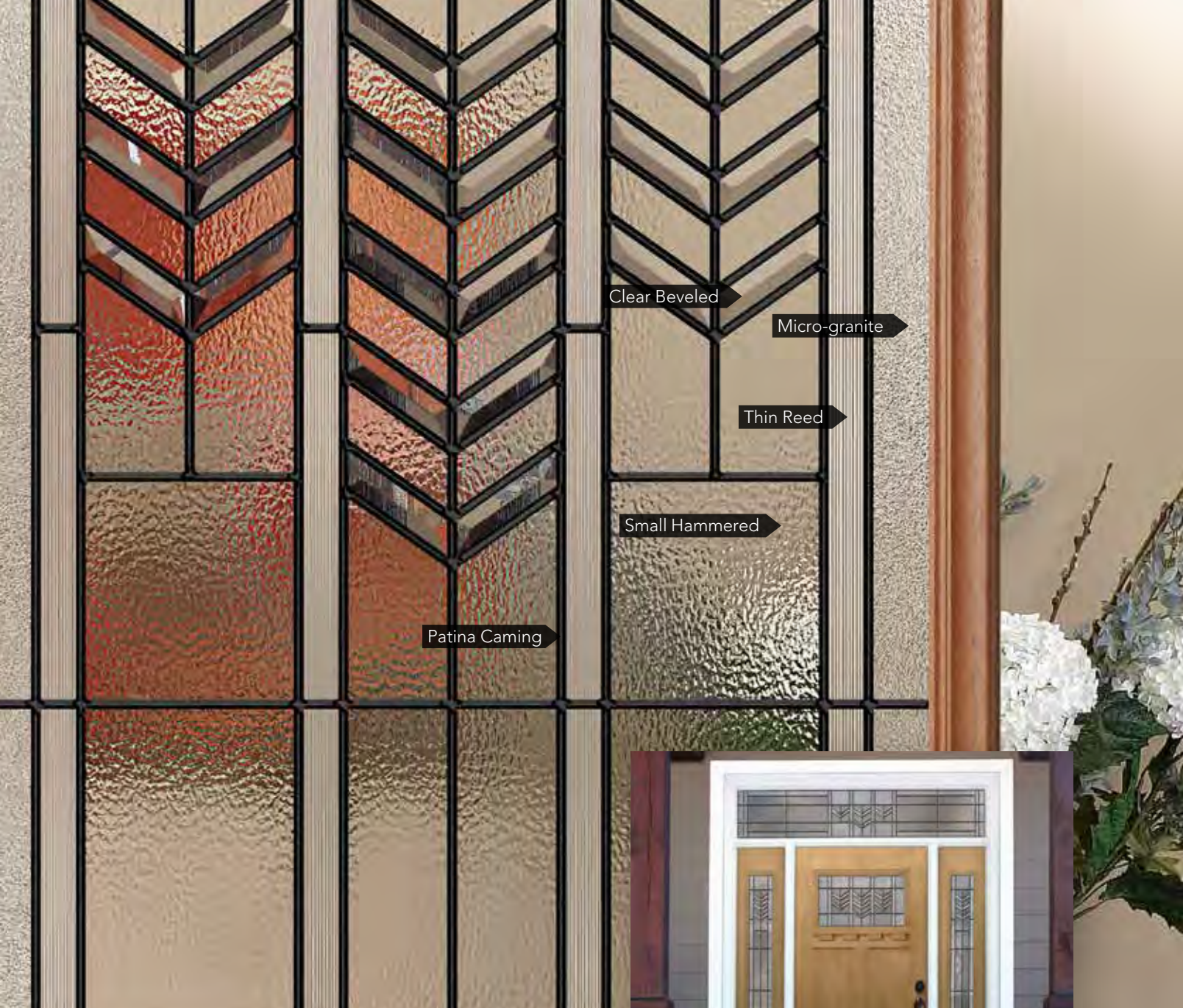

Clear Beveled

Micro-granite

Thin Reed

Small Hammered

Patina Caming



# TACOMA

## DECORATIVE GLASS

Tacoma features hammered and micro-granite design reminiscent of the Arts and Crafts period. Tacoma adds a southwestern inspired theme bringing heritage and legacy to your door.

### CAMING FINISH

Patina

### PRIVACY RATING

1 2 3 4 5 **6** 7 8 9 10

less privacy

more privacy

### LIFETIME LIMITED WARRANTY

Includes Glass Breakage & Seal Failure



All full wood frame and composite frame entry systems using Tacoma Glass are ENERGY STAR® Certified and some steel L-Frame entry systems using Tacoma Glass are ENERGY STAR Certified. See the ENERGY STAR section of our website for energy ratings on specific styles.

612/613TAC ☼ †



160TAC 460TAC 160TAC

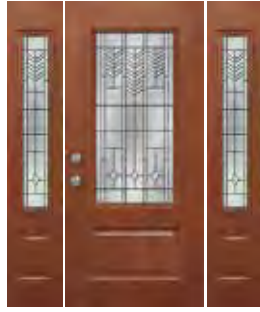

140TAC 440TAC † 140TAC

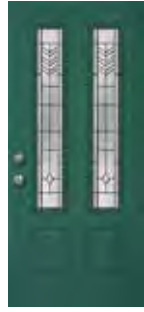

240TAC

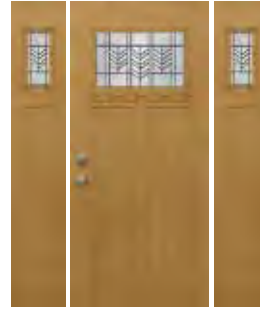

120TAC 420TAC-DS 120TAC

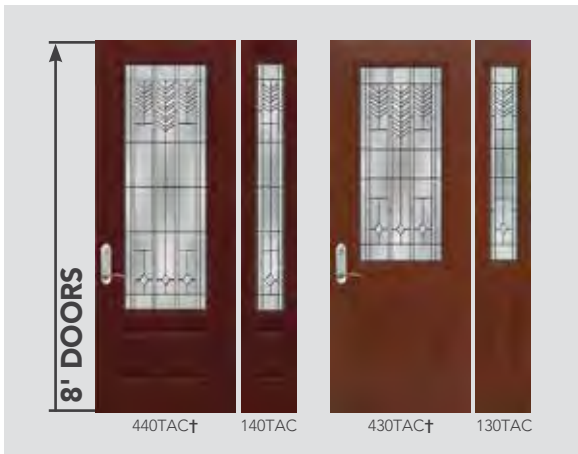

8' DOORS

440TAC † 140TAC 430TAC † 130TAC

† For additional door panel styles see pg. 10 (for Embarq®), pg. 14 (for Signet®), pg. 16 (for Heritage™) or pg. 18 (for Legacy™)  
 ‡ Requires an additional 6-week lead time  
 ☼ Cannot be mulled with Heritage Fiberglass doors in Certified Wind Load regions





Small Hammered

Zinc Caming

Micro-granite

Clear Beveled



# SOMERSET

## DECORATIVE GLASS

Somerset features small hammered, micro granite and clear bevels in a simple yet elegant design that gives a fresh look to your entryway.

### CAMING FINISH

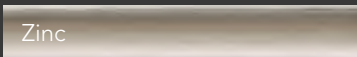

### PRIVACY RATING

1 2 3 4 5 **6** 7 8 9 10

less privacy

more privacy

### LIFETIME LIMITED WARRANTY

Includes Glass Breakage & Seal Failure



All full wood frame and composite frame entry systems using Somerset Glass are ENERGY STAR® Certified and some steel L-Frame entry systems using Somerset Glass are ENERGY STAR Certified. See the ENERGY STAR section of our website for energy ratings on specific styles.



§ Also available in 10" width. See Price List for design pattern  
 † Requires an additional 6-week lead time  
 ☼ Cannot be mulled with Heritage Fiberglass doors in Certified Wind Load regions

† For additional door panel styles see pg. 10 (for Embarq®), pg. 14 (for Signet®) pg. 16 (for Heritage™) or pg. 18 (for Legacy™)



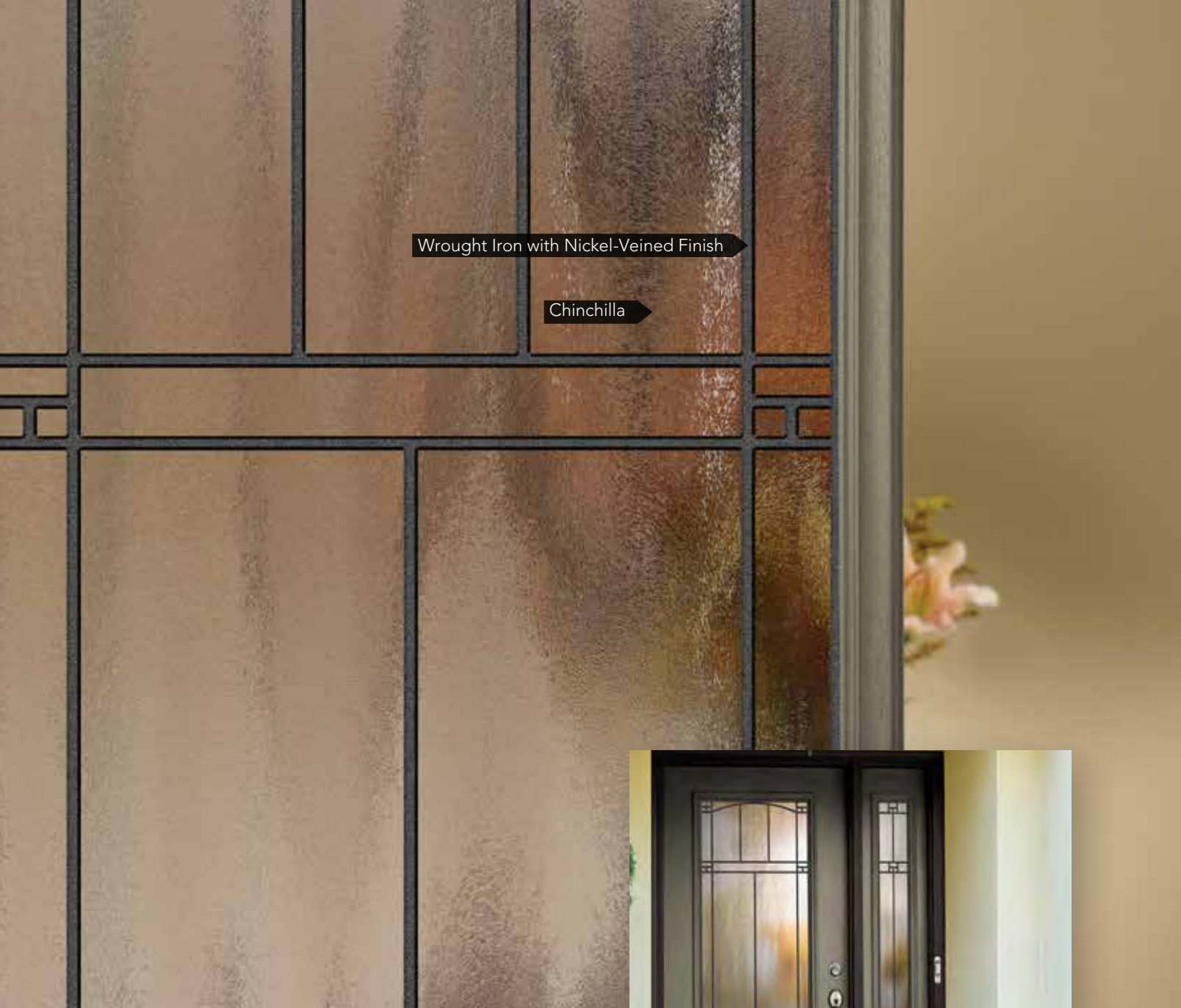

Wrought Iron with Nickel-Veined Finish

Chinchilla



# CARMEN

DECORATIVE GLASS

Carmen features a refreshing new style for an entrance way with old world style charm. Standard with Chinchilla privacy glass and also available in all privacy glass options.

## PRIVACY RATING

1 2 3 4 5 6 7 8 **9** 10

less privacy

more privacy

## LIFETIME LIMITED WARRANTY

Includes Glass Breakage & Seal Failure



All full wood frame and composite frame entry systems using Carmen Glass are ENERGY STAR® Certified and some steel L-Frame entry systems using Carmen Glass are ENERGY STAR Certified. See the ENERGY STAR section of our website for energy ratings on specific styles.

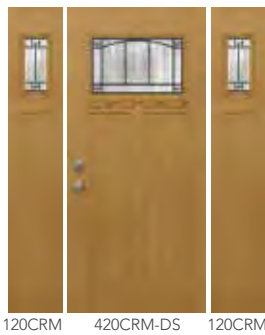
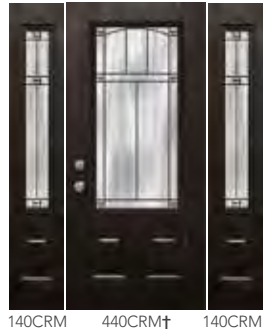
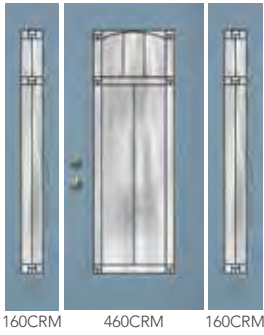

† For additional door panel styles see pg. 10 (for Embarq®), pg. 14 (for Signet®) pg. 16 (for Heritage™) or pg. 18 (for Legacy™)

When you order Carmen glass using the style code CRM, you will receive the standard Chinchilla glass. To order the other Privacy Glass options shown below, use the style codes GLC, TAF, WAT or OBS after the letters CRM (e.g. 460CRM-GLC).



GLUECHIP

PRIVACY RATING



less privacy more privacy



TAFFETA

PRIVACY RATING



less privacy more privacy



WATERFALL

PRIVACY RATING



less privacy more privacy



OBSCURE PEBBLE

PRIVACY RATING



less privacy more privacy





Black Wrought Iron

Gluechip



# BARCELONA

## DECORATIVE GLASS

Barcelona features an exquisite wrought iron design with the option of choosing gluechip (standard), waterfall, taffeta, chinchilla, obscure pebble or clear glass.

### PRIVACY RATING

1 2 3 4 5 6 7 **8** 9 10

less privacy

more privacy

### LIFETIME LIMITED WARRANTY

Includes Glass Breakage & Seal Failure



All Full Wood Frame and Composite Frame Entry Systems using Barcelona Glass are ENERGY STAR® Certified and some Steel L-Frame Entry Systems using Barcelona Glass are ENERGY STAR Certified. See the ENERGY STAR section of our website for energy ratings on specific styles.

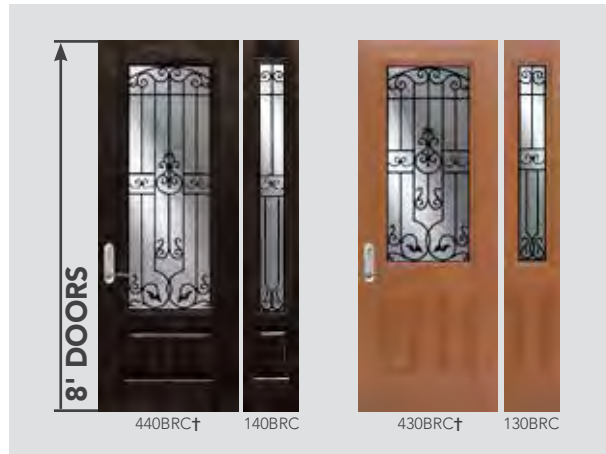
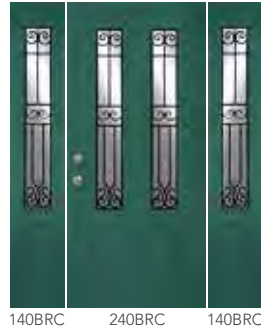
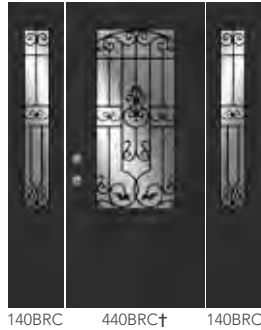

Barcelona Glass

† For additional door panel styles see pg. 10 (for Embarq®), pg. 14 (for Signet®) pg. 16 (for Heritage™) or pg. 18 (for Legacy™)

When you order Barcelona glass using the style code BRC, you will receive the standard Gluechip glass. To order the other Privacy Glass options shown below, use the style codes CHI, TAF, WAT or OBS after the letters BRC (e.g. 460BRC-CHI).

<b>CHINCHILLA</b>	<b>TAFFETA</b>	<b>WATERFALL</b>	<b>OBSCURE PEBBLE</b>
<b>PRIVACY RATING</b>	<b>PRIVACY RATING</b>	<b>PRIVACY RATING</b>	<b>PRIVACY RATING</b>
1 2 3 4 5 6 7 8 <b>9</b> 10	1 2 3 4 5 6 7 8 <b>9</b> 10	1 2 3 4 5 6 7 8 <b>9</b> 10	1 2 3 4 5 6 7 8 <b>9</b> 10
less privacy      more privacy	less privacy      more privacy	less privacy      more privacy	less privacy      more privacy





Caming

Gluechip

Beveled Edge Gluechip

Medium Gray Softwave



# CONSTANCE

## DECORATIVE GLASS

Constance features gluechip, medium gray softwave and beveled edge glue chip resulting in a traditional design that gives your entryway an elegant look.

### CAMING FINISH

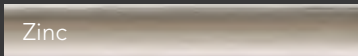

Specify caming finish using these codes:  
Brass - COB, Zinc - COZ

### PRIVACY RATING

1 2 3 4 5 **6** 7 8 9 10

less privacy

more privacy

### LIFETIME LIMITED WARRANTY

Includes Glass Breakage & Seal Failure



All full wood frame and composite frame entry systems using Constance Glass are ENERGY STAR® Certified and some steel L-Frame entry systems using Constance Glass are ENERGY STAR Certified. See the ENERGY STAR section of our website for energy ratings on specific styles.



Constance Glass

§ Also available in 10" width (which requires an additional 4-week lead time). See Price List for design pattern  
† Requires an additional 6-week lead time

‡ For additional door panel styles see pg. 10 (for Embarq®), pg. 14 (for Signet®), pg. 16 (for Heritage™) or pg. 18 (for Legacy™)  
§ Cannot be mulled with Heritage Fiberglass doors in Certified Wind Load regions





# TRANQUILITY

## DECORATIVE GLASS

Tranquility features unique Chinchilla glass accented with beveled clusters and streamed glass.

### CAMING FINISH

Patina

Zinc

Specify caming finish using these codes:  
Patina - TRP, Zinc - TRZ



### PRIVACY RATING

1 2 3 4 5 6 7 **8** 9 10

less privacy

more privacy

### LIFETIME LIMITED WARRANTY

Includes Glass Breakage & Seal Failure



All full wood frame and composite frame entry systems using Tranquility Glass are ENERGY STAR® Certified and some steel L-Frame entry systems using Tranquility Glass are ENERGY STAR Certified. See the ENERGY STAR section of our website for energy ratings on specific styles.

612/613TRP☼



160TRP 460TRP 160TRP

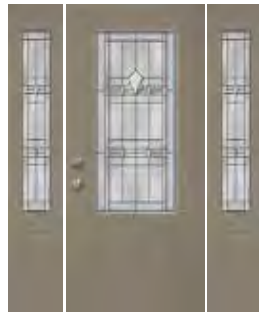

140TRP 440TRP† 140TRP

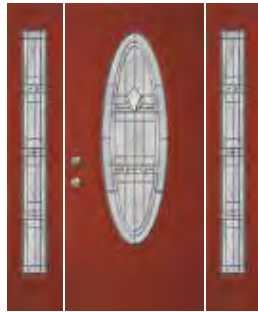

160TRP 350TRP 160TRP



150TRP†



240TRP



243TRP



130TRP 430TRP†



230TRP



419TRP†



400TRP†



110TRP



8' DOORS

440TRZ† 140TRZ 430TRZ† 130TRZ 150TRP

† For additional door panel styles see pg. 10 (for Embarq®), pg. 14 (for Signet®), pg. 16 (for Heritage™) or pg. 18 (for Legacy™)  
 ‡ Requires an additional 6-week lead time  
 ☼ Cannot be mulled with Heritage Fiberglass doors in Certified Wind Load regions





Iced Granite

Clear Beveled

Zinc Caming

Alabaster

Micro-iced Granite



# GEMSTONE

## DECORATIVE GLASS

Beautiful beveled glass with iced and micro-iced granite, accented with zinc caming, gives this classic design a contemporary edge.

### CAMING FINISH

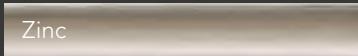

### PRIVACY RATING

1 2 3 4 5 6 7 **8** 9 10

less privacy more privacy

### LIFETIME LIMITED WARRANTY

Includes Glass Breakage & Seal Failure



All full wood frame and composite frame entry systems using Gemstone Glass are ENERGY STAR® Certified and some steel L-Frame entry systems using Gemstone Glass are ENERGY STAR Certified. See the ENERGY STAR section of our website for energy ratings on specific styles.



160GEM 460GEM† 160GEM



140GEM 440GEM† 140GEM



150GEM†



240GEM



243GEM

Gemstone Glass



130GEM 430GEM†



230GEM



419GEM†



† For additional door panel styles see pg. 10 (for Embarq®), pg. 14 (for Signet®), pg. 16 (for Heritage™) or pg. 18 (for Legacy™)

‡ Requires an additional 6-week lead time

⊛ Cannot be mulled with Heritage Fiberglass doors in Certified Wind Load regions





# ECLIPSE

## DECORATIVE GLASS

Eclipse features double gluechip and clusters of bevel with a traditional and harmonious design. Eclipse promotes classical elegance and privacy.

### CAMING FINISH



Specify caming finish using these codes:  
 Brass - ECB, Zinc - ECZ, Patina - ECP

### PRIVACY RATING

1 2 3 4 5 6 **7** 8 9 10

less privacy

more privacy

### LIFETIME LIMITED WARRANTY

Includes Glass Breakage & Seal Failure



All full wood frame and composite frame entry systems using Eclipse Glass are ENERGY STAR® Certified and some steel L-Frame entry systems using Eclipse Glass are ENERGY STAR Certified. See the ENERGY STAR section of our website for energy ratings on specific styles.



† For additional door panel styles see pg. 10 (for Embarq®), pg. 14 (for Signet®), pg. 16 (for Heritage™) or pg. 18 (for Legacy™)  
 ‡ Requires an additional 6-week lead time  
 ✪ Cannot be mulled with Heritage Fiberglass doors in Certified Wind Load regions





# FLORENCE

## DECORATIVE GLASS

This traditional style is accented with a creamy alabaster glass adding interest and appeal that clearly sets it apart from other decorative designs.

### CAMING FINISH

Brass

Patina

Specify caming finish using these codes:  
Brass - FLB, Patina - FLP

### PRIVACY RATING

1 2 3 4 5 6 7 **8** 9 10

less privacy

more privacy

### LIFETIME LIMITED WARRANTY

Includes Glass Breakage & Seal Failure



All full wood frame and composite frame entry systems using Florence Glass are ENERGY STAR® Certified and some steel L-Frame entry systems using Florence Glass are ENERGY STAR Certified. See the ENERGY STAR section of our website for energy ratings on specific styles.

612/613FLP☼

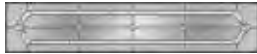

160FLP 460FLP 160FLP



140FLP 440FLP† 140FLP



160FLP 350FLP 160FLP



150FLP†



240FLP



243FLP

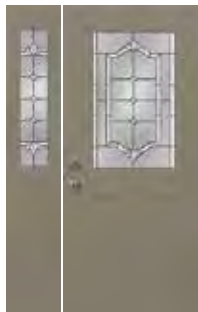

130FLP 430FLP†

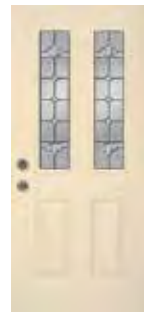

230FLP



419FLP†



400FLP†



8' DOORS

440FLP†

140FLP

430FLP†

130FLP

150FLP

Florence Glass

† For additional door panel styles see pg. 10 (for Embarq®), pg. 14 (for Signet®), pg. 16 (for Heritage™) or pg. 18 (for Legacy™)  
 ‡ Requires an additional 6-week lead time  
 ☼ Cannot be mulled with Heritage Fiberglass doors in Certified Wind Load regions





# ESMOND

## DECORATIVE GLASS

Esmond features small hammered, micro-granite, flat seedy and clear bevels in a splendid old-world style design bringing a unique touch to your entryway.

### CAMING FINISH

Patina

### PRIVACY RATING

1 2 3 4 5 **6** 7 8 9 10

less privacy

more privacy

### LIFETIME LIMITED WARRANTY

Includes Glass Breakage & Seal Failure



All full wood frame and composite frame entry systems using Esmond Glass are ENERGY STAR® Certified and some steel L-Frame entry systems using Esmond Glass are ENERGY STAR Certified. See the ENERGY STAR section of our website for energy ratings on specific styles.



§ Also available in 10" width (which requires an additional 4-week lead time). See Price List for design pattern  
 † Requires an additional 6-week lead time

‡ For additional door panel styles see pg. 10 (for Embarq®), pg. 14 (for Signet®), pg. 16 (for Heritage™) or pg. 18 (for Legacy™)  
 ☼ Cannot be mullied with Heritage Fiberglass doors in Certified Wind Load regions

Esmond Glass



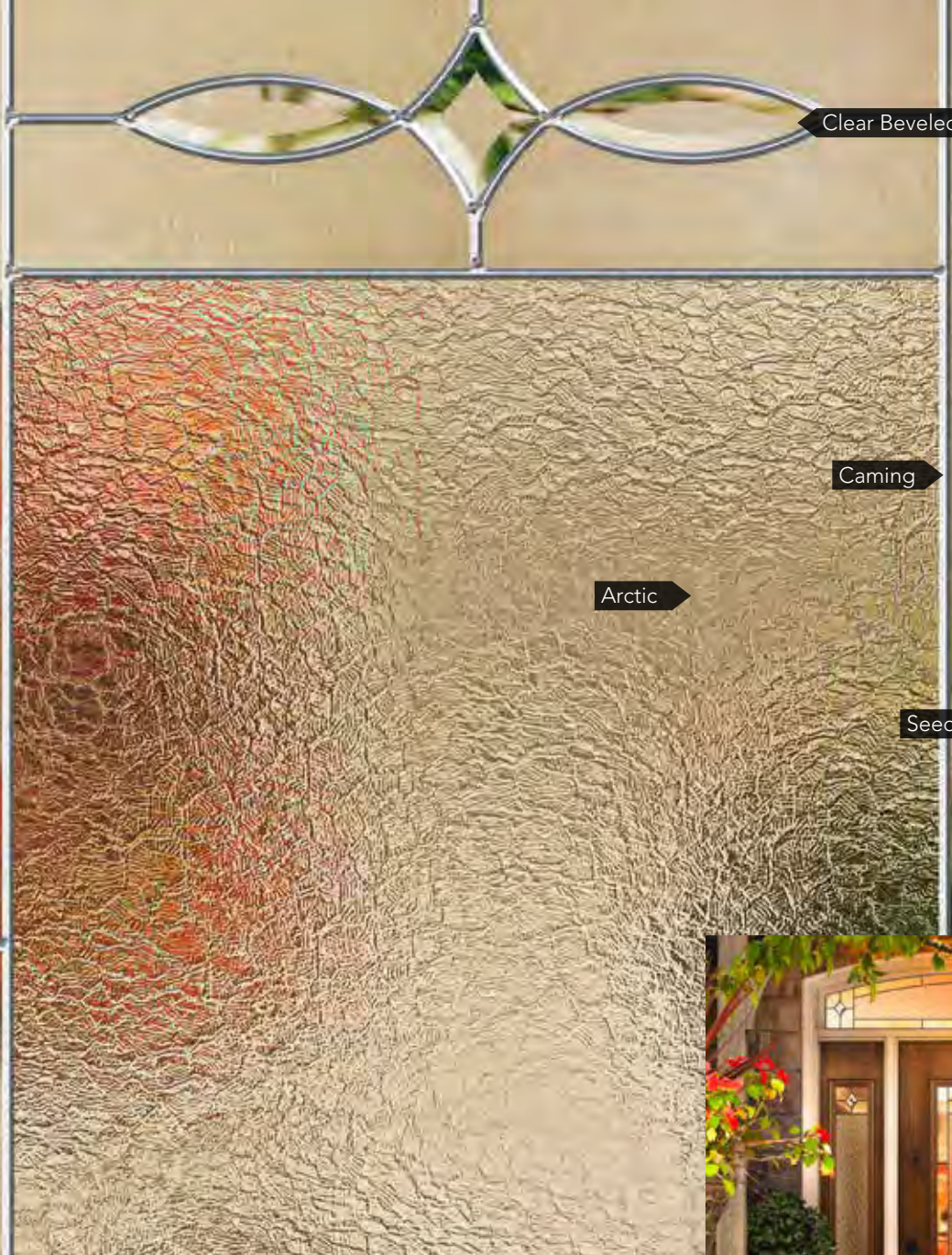

# CARLISLE

## DECORATIVE GLASS

Carlisle features clear bevels, arctic and seedy glass giving an appealing entrance way to any style of home.

### CAMING FINISH



Specify caming finish using these codes:  
Patina - CRP, Zinc - CRZ

### PRIVACY RATING

1 2 3 4 5 6 **7** 8 9 10

less privacy

more privacy

### LIFETIME LIMITED WARRANTY

Includes Glass Breakage & Seal Failure



All full wood frame and composite frame entry systems using Carlisle Glass are ENERGY STAR® Certified and some steel L-Frame entry systems using Carlisle Glass are ENERGY STAR Certified. See the ENERGY STAR section of our website for energy ratings on specific styles.



§ Also available in 10" width (which requires an additional 4-week lead time). See Price List for design pattern  
 † Requires an additional 6-week lead time

† For additional door panel styles see pg. 10 (for Embarq®), pg. 14 (for Signet®), pg. 16 (for Heritage™) or pg. 18 (for Legacy™)  
 ‡ Cannot be mulled with Heritage Fiberglass doors in Certified Wind Load regions





# TWILIGHT

## DECORATIVE GLASS

Twilight is a beautifully decorative silk-screened art. It's unique frosted glass adds to the warmth and privacy of your home.



### PRIVACY RATING

1 2 3 4 5 6 7 **8** 9 10

less privacy

more privacy

### LIFETIME LIMITED WARRANTY

Includes Glass Breakage & Seal Failure



All full wood frame and composite frame entry systems using Twilight Glass are ENERGY STAR® Certified and some steel L-Frame entry systems using Twilight Glass are ENERGY STAR Certified. See the ENERGY STAR section of our website for energy ratings on specific styles.



160TWI 350TWI 160TWI

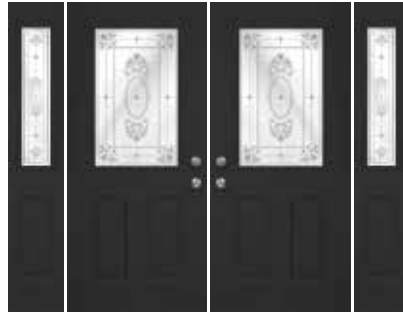

130TWI 430TWI† 430TWI† 130TWI

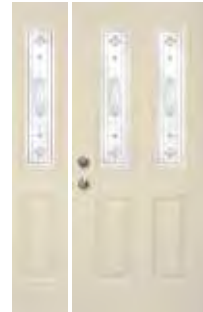

130TWI 230TWI



400TWI†



160TWI 110TWI 160TWI

† For additional door panel styles see pg. 10 (for Embarq®), pg. 14 (for Signet®), pg. 16 (for Heritage™) or pg. 18 (for Legacy™)











# INSPIRATIONS™

## ART GLASS

---

A ProVia® exclusive, Inspirations Art Glass allows you to do just what the name suggests-let your doors reflect the inspiration of your imagination with your choice of design and color.

### DESIGNS

The process begins with conceptual design. Our beautiful Inspirations Art Glass styles originated from the imagination of our in-house designers.

### RESIN BEAD

The design pattern is created on our computer software, and sent to a CNC machine which applies a resin bead to the surface of the glass in one of our four stylish colors.

### COLOR FILL

The color fill truly brings the glass to life. Several colors are offered empowering you to perfectly reflect the personality of you and your home. Our craftsmen hand-apply this color fill to your glass.

### OUR GUARANTEE

The resin bead and color fill are backed by our Lifetime Limited Warranty, and will not fade, blister or peel away from the glass.





## SEE MORE INSPIRATIONS

Ask to see our Inspirations Art Glass brochure for available styles and color palettes, or use our ProVia app to create custom color palettes and design your dream door.



Download our free app today!



Download on entryLINK  
or [provia.com/app](http://provia.com/app)





# PRIVACY GLASS

Privacy glass allows light to filter in, while keeping a high level of privacy.

## CHINCHILLA (CHI)

### PRIVACY RATING



less privacy more privacy



## TAFFETA (TAF)

### PRIVACY RATING

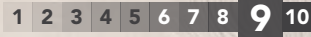

less privacy more privacy



## WATERFALL (WAT)

### PRIVACY RATING

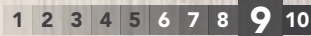

less privacy more privacy



## GLUECHIP (GLC)

### PRIVACY RATING



less privacy more privacy



## OBSCURE PEBBLE (OBS)

### PRIVACY RATING



less privacy more privacy



## LIFETIME LIMITED WARRANTY

Includes Glass Breakage & Seal Failure





Door Styles	Glazing Systems			
	TLK	TLA	DLA	DC
HALF-LITE OR LARGER				
460, 449, 440, 437, 430, 439, 240, 239, 230, 112, 114, 115, 116	●	●	●	●
SMALLER THAN HALF-LITE				
420, 419, 400, 243, 110	●	●	●	●

● ENERGY STAR Certified  
Refer to pg. 28-89 for Glazing Systems information

Since Low-E glass has a slight color tint, it is recommended that sidelites are ordered with the same glazing system as the door.



- † For additional door panel styles see pg. 10 (for Embarq®), pg. 14 (for Signet®), pg. 16 (for Heritage™) or pg. 18 (for Legacy™)
- § Also available in 10" width.
- ⊕ Cannot be milled with Heritage Fiberglass doors in Certified Wind Load regions
- ◆ Only available with Modern Flat Glass Trim. Only available with 770 sidelite(s) or 160 sidelite(s) with Modern Flat Glass Trim.

**Note** - Privacy glass is available in Simulated Divided Lites (see pg. 86) Simulated Divided Panels (pg. 88) and External Grids (see pg 93).





# CLEAR GLASS

**LIFETIME LIMITED WARRANTY**  
Includes Glass Breakage & Seal Failure

Clear Glass is appropriate on every entry of your home and can still be energy efficient.

Door Styles	Glazing Systems			
	TLK	TLA	DLA	DC
HALF-LITE OR LARGER 460, 449, 440, 439, 437, 430, 350, 240, 239, 230, 150, 112, 114, 115, 116	●	●	●	●
SMALLER THAN HALF-LITE 420, 419, 400, 243, 110	●	●	●	●
306, 206, 131, 101, 100				●



All entry systems with Clear Glass can be ENERGY STAR® Certified depending on the glazing system you choose. This chart indicates which glazing system is required for ENERGY STAR certification, as well as availability.

- ENERGY STAR Certified  
Refer to pg. 28-29 for Glazing Systems information

Since Low-E glass has a slight color tint, it is recommended that sidelites are ordered with the same glazing system as the door.



# TRANSOMS



460DC 160DC 440DC† 140DC 113 532DC\* pg. 105 516DC\* pg. 105 612/613DC\* pg. 100 616DC\* pg. 104 712/713DC\* pg. 100 512/513DC\* pg. 101

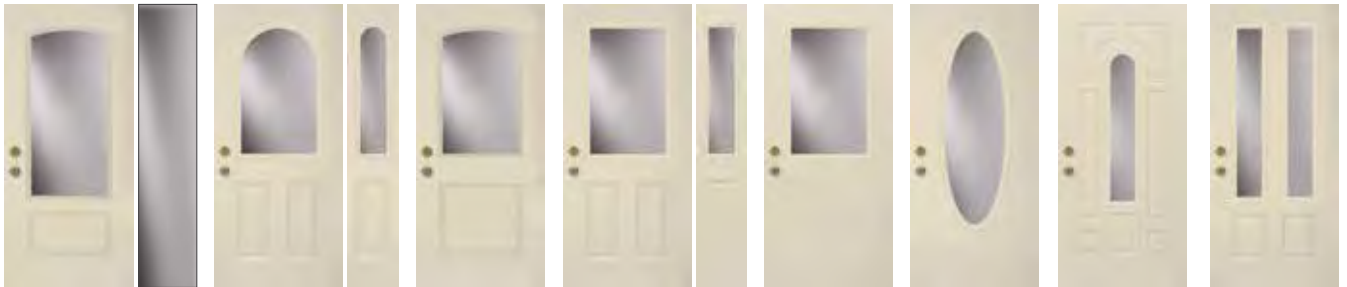

449DC† 770DC§ 439DC† 139DC 437DC† 430DC† 130DC 430DC-F† 350DC 243DC 240DC

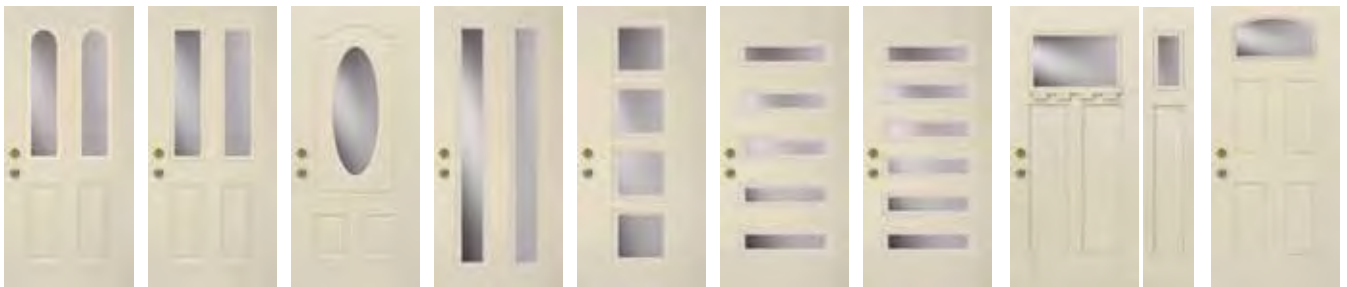

239DC 230DC 150DC† 112DC◆ 114DC◆ 115DC◆ 116DC◆ 420DC-D5† 120DC 419DC†

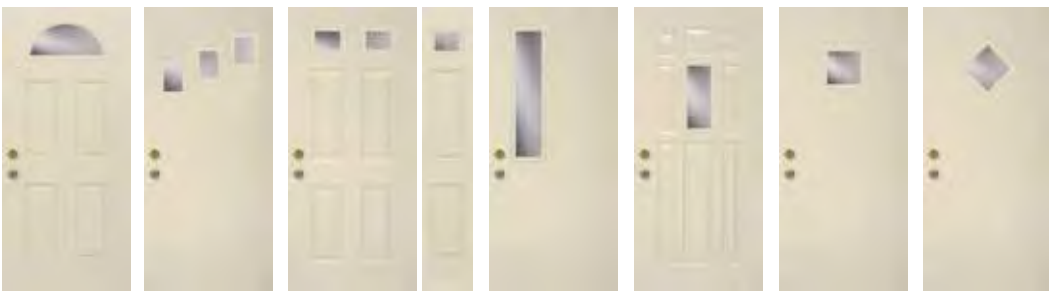

400DC† 306DC 206DC 106DC 131DC 110DC 101DC 100DC

Clear Glass



150DC-1P 770DC§ 114DC◆ 115DC◆ 116DC◆

§ Also available in 10" width.  
 † For additional door panel styles see pg. 10 (for Embarq®), pg. 14 (for Signet®), pg. 16 (for Heritage™) or pg. 18 (for Legacy™)  
 ✪ Cannot be mulled with Heritage Fiberglass doors in Certified Wind Load regions  
 ★ In Certified Wind Load region, indicated transoms must be installed in a separate opening or use approved engineering mulls  
 ◆ Only available with Modern Flat Glass Trim. Only available with 770 sidelite(s) or 160 sidelite(s) with Modern Flat Glass Trim.

**Note** - Clear glass is available in Simulated Divided Lites (see pg. 86) Simulated Divided Panels (see pg. 88) Internal Grids (see pg. 90) ( and External Grids (see pg 93).





Blind operator as viewed from the interior of your home.

# WHITE INTERNAL BLINDS

Internal blinds are constructed with sturdy white aluminum and enclosed in tempered safety glass. Easy to clean; no more dusting of blinds. Internal Blinds are suitable for entry doors, sidelites and patio doors and carry a 20-Year Warranty.

## FEATURES

- Ergo Track on glass
- Eliminated Slat/Privacy Channel Gap
- U-Privacy Channels (side, top & bottom) eliminate light gaps, shadows and sunlight glare
- Full Tilt Closure (top to bottom) allows the blinds to tilt completely closed keeping unwanted light out



All entry systems with Internal Blinds can be ENERGY STAR® Certified depending on the glazing system you choose. This chart indicates which glazing system is required for ENERGY STAR certification, as well as availability.

Door Styles	DLA	DC
INTERNAL BLINDS		
With Internal Grids	●	●
INTERNAL BLINDS		
Without Grids	●	●

ENERGY STAR Certified  
Refer to pg. 28-29 for Glazing Systems information

Since Low-E glass has a slight color tint, it is recommended that sidelites are ordered with the same glazing system as the door.

WITH **TRADITIONAL** (COLONIAL) INTERNAL GRIDS



WITH **PRAIRIE** INTERNAL GRIDS



WITH **COTTAGE** INTERNAL GRIDS



BLINDS **WITHOUT** INTERNAL GRIDS

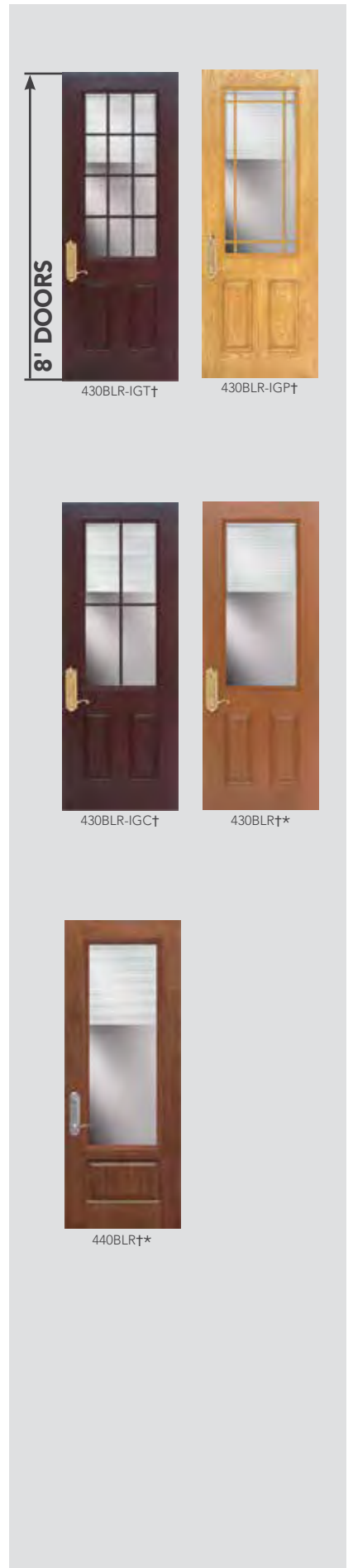

Internal Blinds

† For additional door panel styles see pg. 14 (for Signet®), pg. 16 (for Heritage™) or pg. 18 (for Legacy™)  
 \* On Signet doors, blind operator will be operator pictured on page 90



# COLORED INTERNAL BLINDS

Internal blinds are available in four neutral hues to complement any room in the house. Easy to clean; no more dusting of blinds. Internal blinds are suitable for entry doors and patio doors. Offering a 10-Year Warranty.



Blind operator as viewed from the interior of your home.

## AVAILABLE COLORS

Cream

Tan

Silver

Champagne

(require additional lead time)

*\*colors not available in sidelites*



All entry systems with Internal blinds can be ENERGY STAR® Certified depending on the glazing system you choose. This chart indicates which glazing system is required for ENERGY STAR certification, as well as availability.

BLINDS **WITHOUT** INTERNAL GRIDS



460BLR



440BLR†



430BLR†

WITH **TRADITIONAL (COLONIAL)** INTERNAL GRIDS



460BLR-IGTA

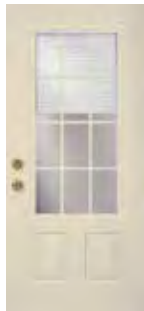

440BLR-IGT†Δ

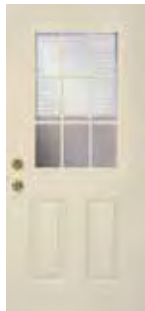

430BLR-IGT†Δ

WITH **PRAIRIE** INTERNAL GRIDS



460BLR-IGPA



440BLR-IGP†Δ



430BLR-IGP†Δ

WITH **COTTAGE** INTERNAL GRIDS



460BLR-IGCA

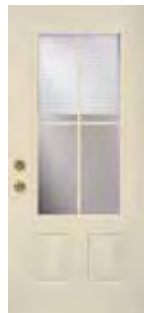

440BLR-IGC†Δ



430BLR-IGC†Δ

† For additional door panel styles see pg. 14 (for Signet®), pg. 16 (for Heritage™) or pg. 18 (for Legacy™)  
 Δ Not available in Signet Series

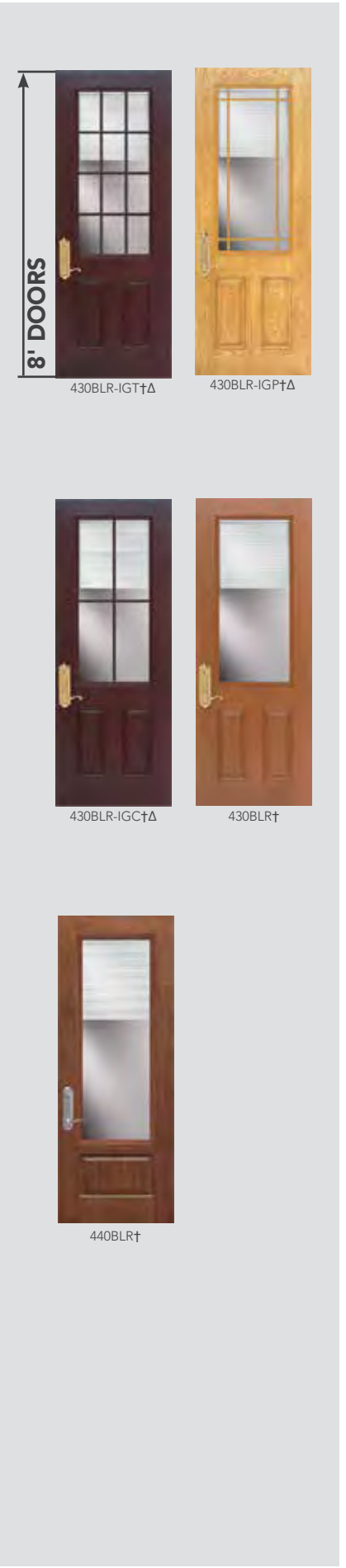

8' DOORS



430BLR-IGT†Δ

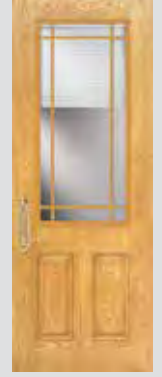

430BLR-IGP†Δ



430BLR-IGC†Δ

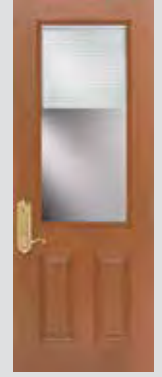

430BLR†



440BLR†

Colored Blinds



# SIMULATED DIVIDED LITES

Simulated Divided Lites (SDL) are reminiscent of old world craftsmanship when separate pieces of glass were mullied together with wooden grids. We deliver that same stunning appearance through our high-tech stained fiberglass 1" wide x 1 1/32" thick grids combined with the energy efficient qualities of our ComforTech glass packages.



## CRAFTSMAN

Only available for Signet Fir Series



## CONTOURED

Available for all styles shown, except for Signet Fir Series



## BEVELED GLASS

The beauty of beveled glass and coming combine for a distinguished take on traditional divided lights.

Each piece of beveled glass is secured with coming for the beautiful look of a true divided light, with the efficiency of a single doorlight.





† For additional door panel styles see pg. 10 (for Embarq®), pg. 14 (for Signet®)  
 ▲ Requires plugless trim

Δ Not Available with beveled glass



All entry systems with Simulated Divided Lites can be ENERGY STAR® Certified depending on the glazing system you choose. This chart indicates which glazing system is required for ENERGY STAR certification, as well as availability.

Note - All doors and sidelites with SDL's are available with privacy glass.  
 Note - SDL's match stain or paint of door.

(See pages 10-21 for Impact Shield & Windload availability)



NEW

# SIMULATED DIVIDED PANELS

For a stylish and modern look, Simulated Divided Panel fiberglass doors feature wider SDL's (3" and/or 5") applied to the surface of glass on a 460 style Fir door or directly onto the skin of a 001 style Fir door. Numerous configurations and endless paint, glaze or stain colors allow you to create a door design that is contemporary, sophisticated and on-trend.

**Note** - Available only in Signet® Fir with Clear glass (see pg. 80) or Privacy glass (see pg. 78)  
Simulated Divided Panel designs can not be customized

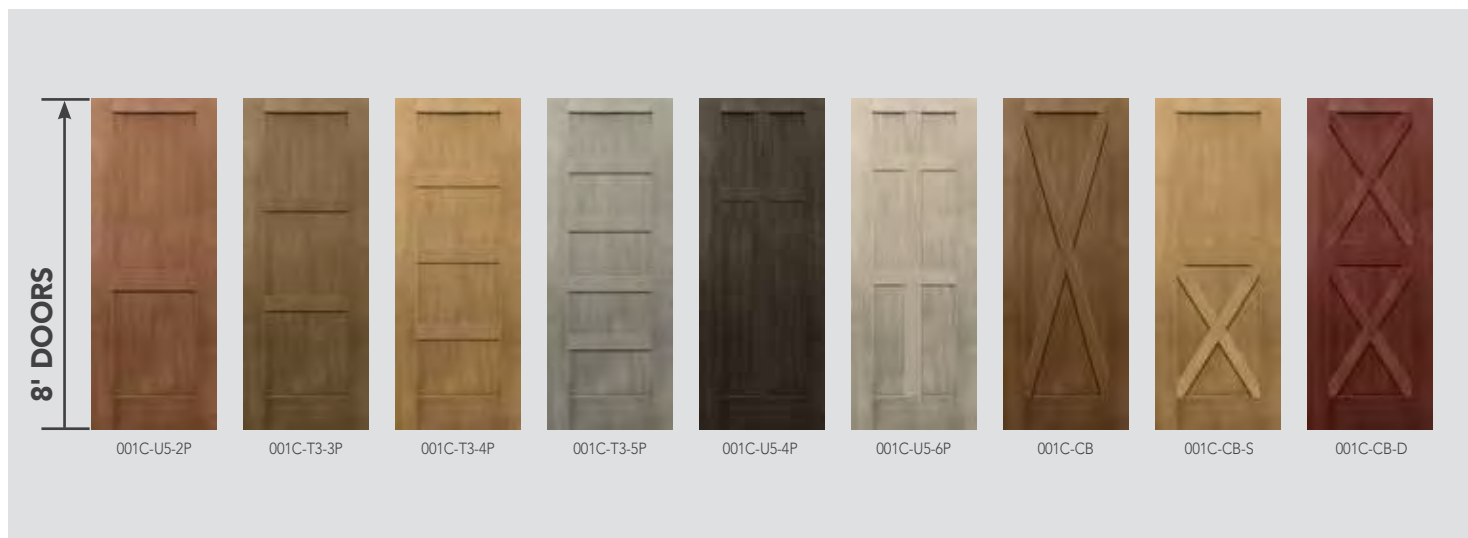



460-C5 160-C5 460-T3-3L 160-T3-3L 460-T5-4L 160-T5-4L 460-T3-5L 160-T3-5L 460-T3-6L 160-T3-6L 460-UM-7L 160-UM-7L



460-T5-8L 460-M3 001C-U5-2P 001C-T3-3P 001C-T3-4P 001C-T3-5P 001C-U5-4P



001C-U5-6P 001C-CB 001C-CB-S 001C-CB-D

Simulated Divided Panels

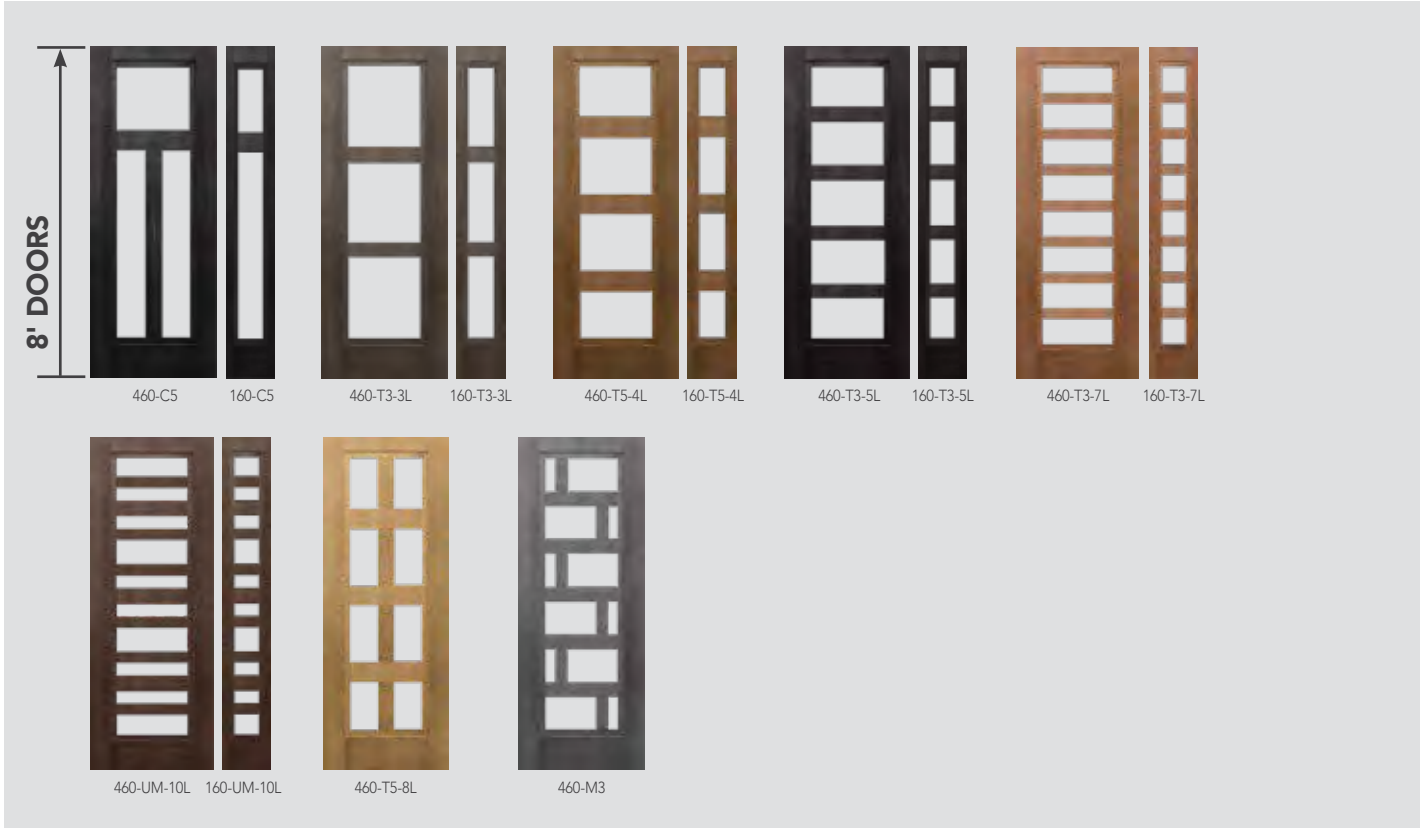

460-C5 160-C5 460-T3-3L 160-T3-3L 460-T5-4L 160-T5-4L 460-T3-5L 160-T3-5L 460-T3-7L 160-T3-7L  
 460-UM-10L 160-UM-10L 460-T5-8L 460-M3





## INTERNAL GRIDS OPTIONS

Note: Pencil Grids are not available in Prairie Grids on some indicated doors and transoms

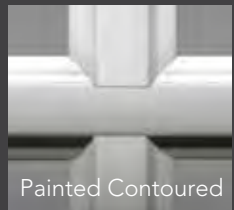
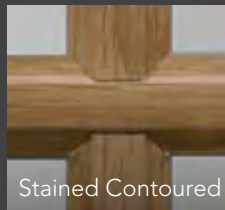
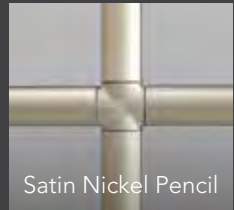
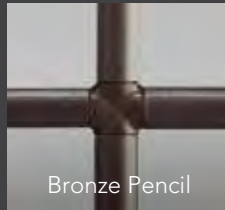
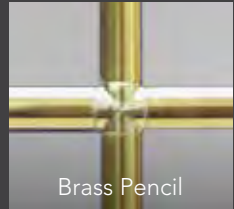

# INTERNAL GRIDS

## CONTOURED GRID COLORS AND STAINS

Snow Mist	Café Cream	Sandpiper Beige	Sandstone	Clay	Forest Green	Mountain Berry	Rustic Bronze
Tudor Brown	Coal Black†	Honey Wheat† & Light Oak†	American Cherry† & Cherry†				

## TWO-TONE CONTOURED GRIDS

Snow Mist	Snow Mist	Snow Mist	Snow Mist	Snow Mist	Snow Mist	Snow Mist
Café Cream	Sandpiper Beige	Sandstone	Forest Green	Mountain Berry	Coal Black†	Honey Wheat† & Light Oak†
Snow Mist	Snow Mist	Snow Mist	Sandpiper Beige	Sandpiper Beige	Sandpiper Beige	Sandpiper Beige
Almond† & Dark Oak†	American Cherry† & Cherry†	Toffee† & Traditional Cherry†	Honey Wheat† & Light Oak†	Almond† & Dark Oak†	American Cherry† & Cherry†	Toffee† & Traditional Cherry†
Sandstone	Sandstone	Sandstone	Sandstone			
Honey Wheat† & Light Oak†	Almond† & Dark Oak†	American Cherry† & Cherry†	Toffee† & Traditional Cherry†			

**460 STYLES**  
 IGP, IGC, IGC-TS  
 N/A in Pencil Grids

**160 STYLES**  
 IGP, IGC, IGC-TS  
 N/A in Pencil Grids

**440 STYLES**  
 IGP†, IGC†  
 N/A in Pencil Grids

**140 STYLES**  
 IGC, IGP  
 N/A in Pencil Grids

**430 STYLES**  
 IGP†, IGC†, IGC-TS

**130 STYLES**  
 IGP, IGC, IGC-TS

**230 STYLES**  
 IGP, IGC

**240 STYLES**  
 IGP, IGC  
 N/A in Pencil Grids

**449 STYLES**  
 IGP†, IGC†  
 N/A in Pencil Grids

**770 STYLES**  
 IGP‡, IGC‡  
 N/A in Pencil Grids

**437 STYLES**  
 IGP†, IGC†  
 N/A in Pencil Grids

**420DS STYLES**  
 IG6-DS†, IGP-DS†, IGC-DS†

**120 STYLES**  
 IGC, IG4

**420 STYLES**  
 IG6†, IGP†, IGC†

460DC-IGT 160DC-IGT

440DC-IGT† 140DC-IGT

430DC-IGT† 130DC-IGT

230DC-IGT

240DC-IGT

449DC-IGT† 770DC-IGT‡

437DC-IGT†

400DC-IGT†

419DC-IGC†

420DC-IGT-DS† 120DC-IGT

§ Also available in 10" width.  
 \*\* Requires an additional 4-week lead time  
 † For additional door panel styles see pg. 10 (for Embarq®), pg. 14 (for Signet®), pg. 16 (for Heritage™) or pg. 18 (for Legacy™)  
 ‡ Cannot be milled with Heritage Fiberglass doors in Certified Wind Load regions  
 \* In Certified Wind Load region, indicated transoms must be installed in a separate opening or use approved engineering mulls

All entry systems with Internal Grids can be ENERGY STAR® Certified depending on the glazing system you choose. This chart indicates which glazing system is required for ENERGY STAR certification, as well as availability.

Door Styles	Glazing Systems		
	TLA	DLA	DC
HALF-LITE OR LARGER			
460, 440, 430, 240, 230	●	●	●
430, 440 Heritage Fiberglass only	●	●	●
449, 437		●	●
SMALLER THAN HALF-LITE			
420, 419, 400	●	●	●

ENERGY STAR Certified  
 Refer to pg.28-29 for Glazing Systems information  
 Since Low-E glass has a slight color tint, it is recommended that sidelites are ordered with the same glazing system as the door.



# INTERNAL GRIDS CONT'D

## TRANSOMS



512/513DC-IGS  
Not available in Pencil Grids



612/613DC-IGS  
Not available in Pencil Grids



532DC-IGS\*



616DC-IGT



516DC-IGS\*



612/613DC-IGT



712/713DC-IGS\*\*



616DC-IGP

Not available in Pencil Grids

8' DOORS

440DC-SDT† 140DC-SDT

**440 STYLES**

IGP†  
N/A in Pencil Grids

IGC†

IGT†

IGC†-TS

IGC

IGP

IGC-TS  
N/A in Pencil Grids

**140 STYLES**

§ Also available in 10" width.  
\*\* Requires an additional 4-week lead time  
† For additional door panel styles see pg. 10 (for Embarq®), pg. 14 (for Signet®), pg. 16 (for Heritage™) or pg. 18 (for Legacy™)  
\* Cannot be milled with Heritage Fiberglass doors in Certified Wind Load regions  
\* In Certified Wind Load region, indicated transoms must be installed in a separate opening or use approved engineering mulls

8' DOORS

430DC-IGP† 130DC-IGP

N/A in Pencil Grids

N/A in Pencil Grids

**430 STYLES**

IGT†

IGC†

**130 STYLES**

IGT

IGC

420DC-IGT-DSt† 120DC-IGT

**420DS STYLES**

\*IG6-DSt

\*IG2-DSt

\*IGC-DSt

**120 STYLES**

IGC

IG4

\*available with or without dental shelf.

8' DOORS

437DC-IGP† 770DC-IGC§

N/A in Pencil Grids

**437 STYLES**

IGT†

IGC†

**770 STYLES**

IGT§

460DC-IGC 160DC-IGC

**460 STYLES**

IGT

**160 STYLES**

IGT

92

# EXTERNAL GRIDS

**LIFETIME LIMITED WARRANTY**  
Includes Glass Breakage & Seal Failure



160DC-EG 460DC-EG 160DC-EG

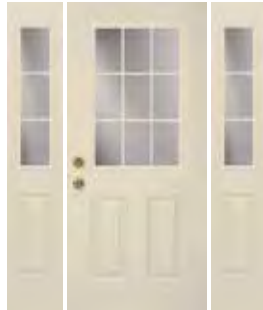

130DC-EG 430DC-EG† 130DC-EG

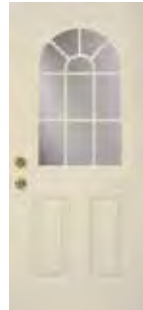

439DC-EG



230DC-EG



410DC-EG Δ



400DC-EG†

External grids will match the door's paint or stain color.

**Note:** All doors with external grids (except for 410 style) are available with privacy glass.

† For additional door panel styles see pg.16 (for Heritage™) or pg. 18 (for Legacy™)  
Δ Not available in 1" warm edge. Also, Glass trim screw plugs are not available for this door style.



All entry systems with External Grids can be ENERGY STAR® Certified depending on the glazing system you choose. This chart indicates which glazing system is required for ENERGY STAR certification, as well as availability.

Door Styles	Glazing Systems			
HALF-LITE OR LARGER	TLK	TLA	DLA	DC
460, 430, 439, 230	●	●	●	●
SMALLER THAN HALF-LITE				
410				●
400	●	●	●	●

● ENERGY STAR Certified  
Refer to pg. 28-29 for Glazing Systems information

Since Low-E glass has a slight color tint, it is recommended that sidelites are ordered with the same glazing system as the door.



# STAIN FINISHES

**Applied with care, by professionals.** If you buy an entry system and finish it yourself, chances are it's the first door you've ever painted or stained. At ProVia®, stains are hand-applied by professional craftsmen, many who have been perfecting their work for years.



# EMBARQ® & SIGNET®

## 7-STEP STAIN FINISHING SYSTEM



1. **DURAFUSE™** - Proprietary P<sup>3</sup> Fusion Preparation Processes ensuring unprecedented finish durability
2. **HAND-APPLIED STAIN FINISH** formulated exclusively for Signet fiberglass doors
3. A layer of 2-part urethane, catalyst-hardened **CLEAR COAT WITH UV INHIBITORS** is applied
4. Clear coat is **OVEN-CURED** for lasting durability
5. The door is **HAND-SANDED**, preparing the surface for the second layer of clear coat
6. A second layer of 2-part urethane, catalyst-hardened **CLEAR COAT WITH UV INHIBITORS** is applied
7. The door is **OVEN-CURED** a second time, creating a long-lasting, durable finish

### Cherry & Mahogany Stains (shown on Cherry)

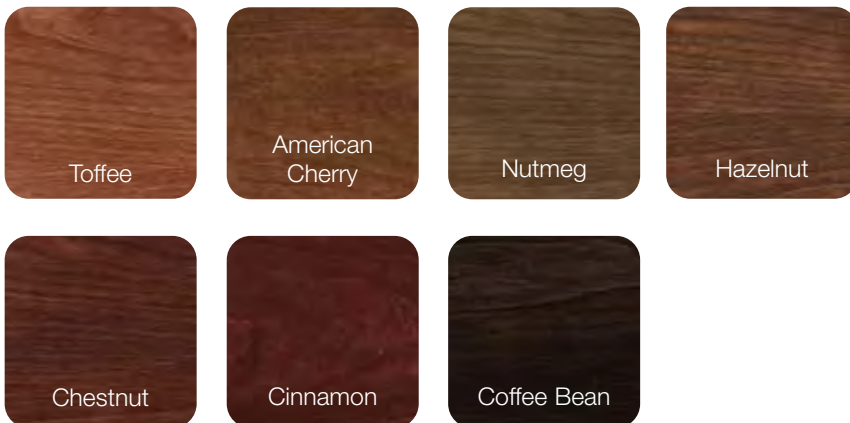

### Oak, Knotty Alder & Fir Stains (shown on Oak)

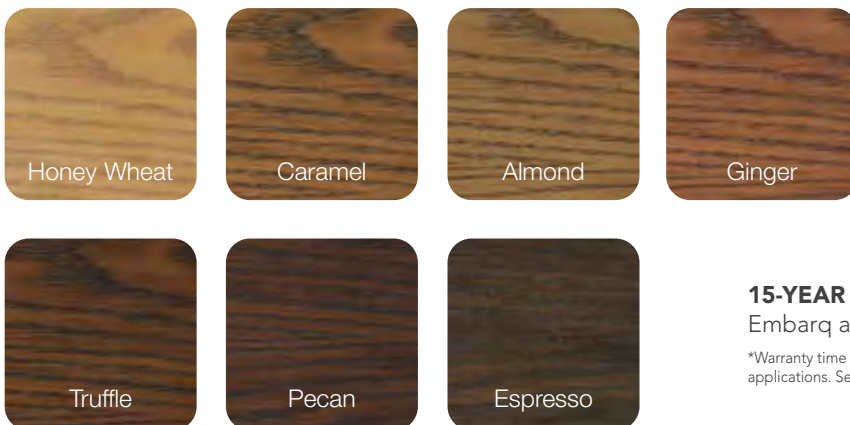

### 15-YEAR FINISH WARRANTY\*

Embarq and Signet Fiberglass

\*Warranty time period may be limited in extreme exposure applications. See warranty for details.

Always refer to our color selector for accurate color representation.



# EMBARQ® & SIGNET® GLAZED FINISHES

Distinctive beauty achieved through a creative hand-applied finish giving each door a unique aged look.

## 9-STEP GLAZED FINISHING SYSTEM



1. **DURAFUSE™** - Proprietary P<sup>3</sup> Fusion Preparation Processes ensuring unprecedented finish durability
2. A 2-part urethane, catalyst-hardened **BASE COAT** (prime paint) is applied
3. Base coat is **OVEN-CURED** for lasting durability
4. **HAND-APPLIED STAIN FINISH** formulated exclusively for Signet fiberglass doors
5. A layer of 2-part urethane, catalyst-hardened **CLEAR COAT WITH UV INHIBITORS** is applied
6. Clear coat is **OVEN-CURED** for lasting durability
7. The door is **HAND-SANDED**, preparing the surface for the second layer of clear coat
8. A second layer of 2-part urethane, catalyst-hardened **CLEAR COAT WITH UV INHIBITORS** is applied
9. The door is **OVEN-CURED** a second time, creating a long-lasting, durable finish

Knotty Alder, Mahogany, Fir, Cherry & Oak Glazed Finishes (Shown on Oak)

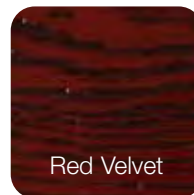
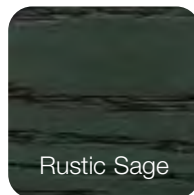

## 15-YEAR FINISH WARRANTY\*

Embarq and Signet Fiberglass

\*Warranty time period may be limited in extreme exposure applications. See warranty for details.

Always refer to our color selector for accurate color representation.

# HERITAGE™ & LEGACY STEEL™

## LEGACY

### 6-STEP STAIN FINISHING SYSTEM



1. Steel doors are **A40 Hot-dipped Galvannealed** (300% more coating thickness than 40Z full electrolytic zinc coated steel) to resist rust inside and out
2. A 2-part urethane, catalyst-hardened **BASE COAT** (prime paint) is applied by a robotic reciprocating paint system
3. Base coat is **OVEN-CURED** for lasting durability
4. **HAND-APPLIED STAIN FINISH** is added for enhanced beauty
5. A layer of 2-part urethane, catalyst-hardened **CLEAR COAT WITH UV INHIBITORS** is applied
6. The door is **OVEN-CURED** a second time, creating a long-lasting, durable finish

## HERITAGE

### 5-STEP STAIN FINISHING SYSTEM



1. A 2-part urethane, catalyst-hardened **BASE COAT** (prime paint) is applied by a robotic reciprocating paint system
2. Base coat is **OVEN-CURED** for lasting durability
3. **HAND-APPLIED STAIN FINISH** is added for enhanced beauty
4. A layer of 2-part urethane, catalyst-hardened **CLEAR COAT WITH UV INHIBITORS** is applied
5. The door is **OVEN-CURED** a second time, creating a long-lasting, durable finish

Heritage & Legacy Stains (shown on Oak)

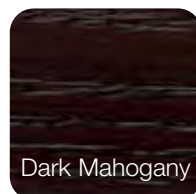
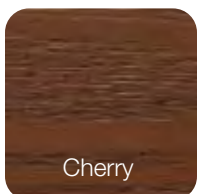

### 10-YEAR FINISH WARRANTY\*

Heritage and Legacy Doors

\*Warranty time period may be limited in extreme exposure applications. See warranty for details.

Always refer to our color selector for accurate color representation.



# PAINT FINISHES

**We do the finishing, so you don't have to.**

You wouldn't try to paint a car yourself, so why should it be any different when it comes to staining or painting your entry door?



## LEGACY

### 5-STEP PAINT FINISHING SYSTEM

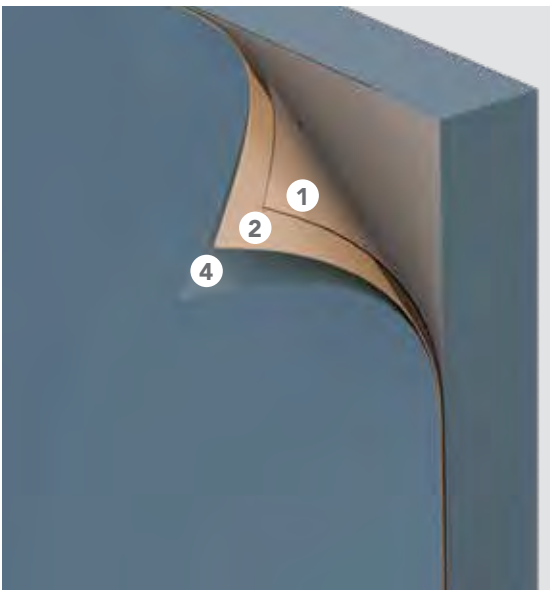

1. Steel doors are **A40 Hot-dipped Galvannealed** (300% more coating thickness than 40Z full electrolytic zinc coated steel) to resist rust inside and out
2. A 2-part urethane, catalyst-hardened **BASE COAT** (prime paint) is applied by a robotic reciprocating paint system
3. Base coat is **OVEN-CURED** for lasting durability
4. The door is then coated with a 2-part urethane, catalyst-hardened **FINISH COAT**
5. The door is **OVEN-CURED** a second time, creating a long-lasting, durable finish

## HERITAGE

### 4-STEP PAINT FINISHING SYSTEM



1. A 2-part urethane, catalyst-hardened **BASE COAT** (prime paint) is applied by a robotic reciprocating paint system
2. Base coat is **OVEN-CURED** for lasting durability
3. The door is then coated with a 2-part urethane, catalyst-hardened **FINISH COAT**
4. The door is **OVEN-CURED** a second time, creating a long-lasting, durable finish

### 10-YEAR FINISH WARRANTY\*

Heritage and Legacy Doors

\*Warranty time period may be limited in extreme exposure applications. See warranty for details.

# EMBARQ<sup>®</sup>, SIGNET<sup>®</sup>, HERITAGE<sup>™</sup> & LEGACY<sup>™</sup> STEEL PAINT FINISHES

## EMBARQ AND SIGNET

### 5-STEP PAINT FINISHING SYSTEM

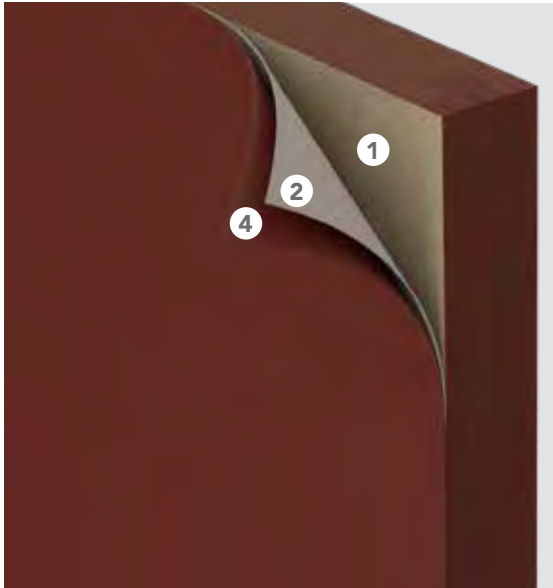

1. **DURAFUSE<sup>™</sup>** - Proprietary P<sup>3</sup> Fusion Preparation Processes ensuring unprecedented finish durability
2. A 2-part urethane, catalyst-hardened **BASE COAT** (prime paint) is applied by a robotic reciprocating paint system
3. Base coat is **OVEN-CURED** for lasting durability
4. The door is then coated with a 2-part urethane, catalyst-hardened **FINISH COAT**
5. The door is **OVEN-CURED** a second time, creating a long-lasting, durable finish

### 15-YEAR FINISH WARRANTY\*

Embarq and Signet Fiberglass

\*Warranty time period may be limited in extreme exposure applications. See warranty for details.



Always refer to our color selector for accurate color representation.



# TRENDING COLORS

Color trends are always changing. ProVia's color palette has been completely refreshed to give you even more paint color options for your entry doors, patio doors and storm doors.

All of our traditional hues have been categorized and new "trending" colors have been added, creating three very distinct color palettes to suite your taste: Natural Instincts, Freshly Picked and Stately Shades.

Trending colors  
**AVAILABLE**  
on Storm Doors

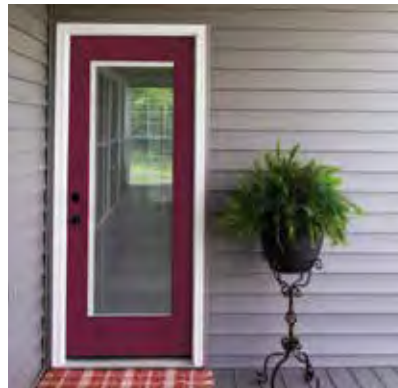

## FRESHLY PICKED PAINT FINISHES

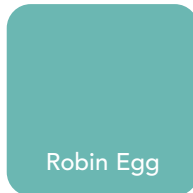

## STATELY SHADES PAINT FINISHES



Always refer to our color selector for accurate color representation.

# CUSTOM PAINT COLORS



Still searching for the perfect color?

Custom color-matching is also available on our Entry Doors, Aeris Patio Doors, Endure Patio Doors (exterior only) and Storm Doors.

Custom stains also available on Signet Fiberglass and Aeris Patio Doors.

*Additional lead-time required.*





# HARDWARE

We offer a variety of designs and finishes, from angular to flowing, classic to contemporary, all with their own security features, unique functionality, and advanced technology. You'll be sure to find the features and design that will ensure your front door is the perfect complement to your new entryway.







# TRILENNIUM<sup>®</sup> MULTI-POINT

HARDWARE

The Trilennium Multi-Point locking system provides more than just security. It offers homeowners better door closure and sealing than a single point lock.

- Three 1" deadbolts latch with deadbolt throw
- Deadbolts include anti-saw hardened steel pin.
- A solid I-beam runs the full length of the lock, and increases the strength and precision of the lock.
- Latch and deadbolt release with a single downward movement.

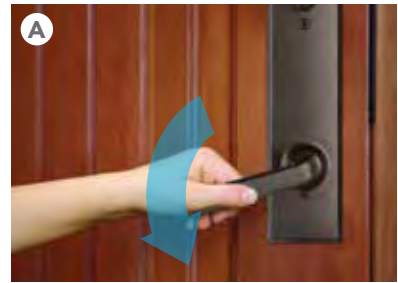

Top and bottom latch design allows for door misalignment and  $\frac{3}{16}$ " pull-in when deadbolted.

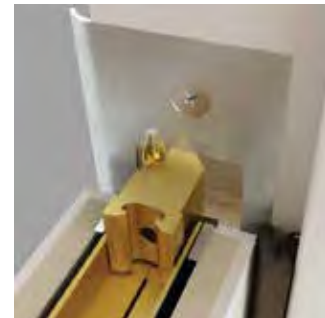

## ECLIPSE



Trilennium hardware is required on all 8' Signet® and Heritage™ fiberglass doors. Optional on all other fiberglass doors.

Also available on all 20-gauge Legacy steel doors.

NOT available on Steel L-Frames

Trilennium hardware has a 10-Year warranty on materials and workmanship.

Trilennium hardware is NOT available on French Doors in Certified Wind Load or Impact Shield regions.

## PINNACLE (Not available in Black Finish)



## TRILENNIUM HARDWARE IS AVAILABLE IN THESE FINISHES

- Lifetime Bright Brass
- Lifetime Satin Nickel
- Lifetime Flat Bronze\*
- Lifetime Black

\* Flat Bronze does not coordinate with Black/Bronze accessories.

Lifetime finish warranty time period is limited to five years if product is installed in a coastal region.

## WESTCOTT (Not available in Bright Brass Finish)





# HOPPE® MULTI-POINT

HARDWARE

Hoppe Multi-Point hardware offers the additional security of four points of latching when the door is locked, and the easy operation of one point of latching when the door is unlocked.

- Stainless Steel and other non-corrosive components.
- Anti-Back Drive prevents locking points from disengaging from the outside for added security.
- Latch Blocker on inactive systems will not allow multipoint activation until inactive system is activated.
- Lock Out Feature on interior system allows for multipoint activation from the exterior of the door by lifting handle.
- Backplate and cylinder housing are forged into one piece for improved appearance and easier installation.
- Simultaneous retraction feature enables all locking points to be retracted by pushing down on the inside handle.

## HOPPE HARDWARE IS AVAILABLE IN THESE FINISHES

Lifetime Bright Brass

Lifetime Satin Nickel

(Hoppe hardware is NOT tested for Certified Wind Load or Impact Shield regions)

Lifetime finish warranty time period is limited to five years if product is installed in a coastal region.

\*Not available on steel I-frames, patio units, and french doors

## EXTERIOR STYLES



New Orleans Contemporary Arch



New Orleans Classic Arch

## INTERIOR STYLES



New Orleans Contemporary Arch



New Orleans Classic Arch

### MULTI-POINT LOCKING

(Lock body faceplate is only available in stainless steel)

**A**  
Three Point Deadbolt lock is engaged by lifting handle upward

**B**  
Handleset latch

**TO LOCK:**  
**Step 1:** Turn thumbturn ¼ turn counterclockwise

**Step 2:** Lift handle upward



EMTEK's Mortise hardware features the added advantages and options that come with push-button controls.

- Push-button passage controls  
*For more passage and locking options*
- Heavy-duty Forged Brass Construction - *For long lasting beauty*
- Solid Brass Nose Bolts on Latches - *For dependable use*
- Lifetime Mechanical Warranty  
*Our guarantee of value*
- Lifetime Anti-tarnish Finish  
*Warranty - Beauty for life*

Push button passage controls provide added security and peace of mind. When the upper button is pressed in, the mortise lock is only accessible by using a key.

To activate the Passage Function, push in the lower button. This will allow you to access the thumb latch without a key.

Note: As long as the Passage Function is NOT engaged, the door will lock automatically when latched, and will not allow entry without a key.

## EMTEK MORTISE HARDWARE IS AVAILABLE IN THESE FINISHES

Lifetime Bright Brass

NEW

Lifetime Satin Brass

Lifetime Satin Nickel

Lifetime Oil Rubbed Bronze

Lifetime Black

(EMTEK Mortise hardware is NOT tested for Certified Wind Load or Impact Shield regions)

Lifetime finish warranty time period is limited to five years if product is installed in a coastal region.

(EMTEK Mortise hardware is only available for Signet Fiberglass and 20-gauge steel doors)

# EMTEK<sup>®</sup> MORTISE

HARDWARE

▶ See video at [provia.com/provia-videos](https://provia.com/provia-videos) for features and operation



## EXTERIOR STYLES



Craftsman • Δ



Memphis •



Manhattan • Δ



**NEW** Adelaide Δ

## INTERIOR STYLES



Oval Beaded  
Egg •  
(Recommended  
on Memphis)



Hammered  
Lever Δ•  
(Recommended  
on Craftsman)



Coventry Lever •  
(Recommended  
on Memphis)



Square Knob • Δ  
(Recommended on  
Manhattan)



**NEW** Helios Lever Δ  
(Recommended on  
Adelaide)

Δ Not available in Bright Brass  
• Not available in Satin Brass



EMTEK's unique Interconnect Device provides the security of a locking deadbolt while providing the means for a panic-proof exit. Turning the interior knob or lever simultaneously retracts both the deadbolt and passage latches.

- Heavy-duty forged brass construction - *For long lasting beauty*
- Durable springs to prevent lever sag
- Threaded brass tubes solid brass nose bolts on latches
- Lifetime mechanical warranty *our guarantee of value*
- Lifetime anti-tarnish finish warranty - *Beauty for life*

**EMTEK HARDWARE**  
IS AVAILABLE IN THESE  
FINISHES

- Lifetime Bright Brass
- NEW** Lifetime Satin Brass
- Lifetime Satin Nickel
- Lifetime Oil Rubbed Bronze
- Lifetime Black

Lifetime finish warranty time period is limited to five years if product is installed in a coastal region.

**EMTEK<sup>®</sup>**  
HARDWARE

**EXTERIOR STYLES**  
(Single Point Lock)



Melrose Δ



Marietta Δ



Orleans • ◇



**NEW** Davos Δ

**MODERN RECTANGULAR**  
(Two Point Lock)

Panic-proof exit not available in Modern Rectangular hardware



Round Knob Δ



Hanover Lever Δ

Hardware

**INTERIOR STYLES**

(Any interior handle can be used with any exterior handle)



Egg Δ  
(Recommended on Melrose)



Egg Δ  
(Recommended on Marietta)



Cortina • ◇  
(Recommended on Orleans)



**NEW** Stuttgart Δ  
(Recommended on Davos)



Round Knob Δ



Hanover Lever Δ

Δ Not available in Bright Brass  
• Not available in Satin Brass  
◇ Not available in Black





# BRINKS® PUSH PULL ROTATE

HARDWARE

Brinks' Home Security Push Pull Rotate Knobs and Levers are the easiest, most comfortable way to open a door. With just one finger, an elbow, or your hip, you can simply push or pull your way through a door. Great if you have your hands full or free!

**BRINKS  
HARDWARE IS  
AVAILABLE IN THESE  
FINISHES**

10-Year Satin Nickel

10-Year Aged Bronze

Finish warranty time period is limited to five years if product is installed in a coastal region.



**PUSH IT**



**PULL IT**

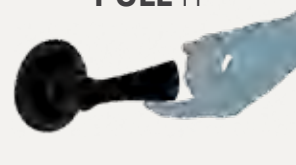

**ROTATE IT**



## EXTERIOR STYLES



Anderson with  
Brynne Deadbolt\*



Harper Lever with  
Almarion Deadbolt



Stafford Knob with  
Almarion Deadbolt\*



## INTERIOR STYLES



Harper Lever with  
Celia Deadbolt



Harper Lever with  
Almarion Deadbolt



Stafford Knob with  
Almarion Deadbolt\*



## EXTERIOR / INTERIOR AVAILABLE COMBINATIONS

Exterior Handles	Interior Levers and Knobs	
	Harper Lever	Stafford Knob
Anderson	•	
Harper	•	
Stafford		•

\*not available for outswing doors



# SCHLAGE® VINTAGE

HARDWARE

Schlage Vintage hardware offers you much more than just great looks. Look to Schlage for hardware that looks great and lasts.

- Solid Cast Brass  
*For long lasting beauty*
- Maximum Security Deadbolt  
*For peace of mind*
- Nickel Silver Pins and Keys  
*For smooth, reliable operation*
- Heavy Duty Springs  
*For durable and "droop-free" levers*
- Superior Parts and Design  
*Tested for over 400,000 cycles of operation*
- Lifetime Mechanical Warranty  
*Our guarantee of value*
- Lifetime Anti-tarnish Finish Warranty  
*Beauty for life*

## SCHLAGE VINTAGE HARDWARE IS AVAILABLE IN THESE FINISHES

- Lifetime Bright Brass
- Lifetime Satin Nickel
- Lifetime Antique Brass
- Lifetime Black

Lifetime finish warranty time period is limited to five years if product is installed in a coastal region.



## EXTERIOR STYLES



Addison\*

Camelot

Plymouth

## INTERIOR STYLES



Georgian

Accent

Flair

Accent/Addison\*

\* Not available in Bright Brass finish



# SCHLAGE® ELECTRONIC KEYPADS



## SCHLAGE SENSE™ SMART DEADBOLT

The Schlage Sense Smart Deadbolt makes daily life easier and more convenient. Enter an access code on the touchscreen to unlock the door instead of searching your pockets for keys. Pairing the lock with your smartphone over Bluetooth® is as easy as pairing your phone with your car, and the free Schlage Sense app makes setting up and using the lock as simple as checking email. Share access with trusted friends and family with just a few taps – no more keeping track of spare keys.



Camelot Trim

Lifetime Satin Nickel

Lifetime Black



Century Trim

Lifetime Satin Nickel

Lifetime Black

# ELECTRONIC DEADBOLT

## ELECTRONIC KEYPAD DEADBOLT



Exterior

Interior

## ACCENT LEVER ELECTRONIC LOCKSET



Exterior

Interior

Electronic locksets and deadbolts utilize Schlage's Innovative keyless access. It's convenient and is customizable to fit your security needs.

- Deadbolt is available with any Schlage entry hardware
- 9-volt battery included
- Lighted keypad
- Up to 19 user codes
- Easy to add or delete codes
- Lifetime Mechanical and 3-Year Electronics Warranty

### AVAILABLE FINISHES

Lifetime Bright Brass

Lifetime Satin Nickel

Lifetime Antique Brass

Lifetime Black

Lifetime finish warranty time period is limited to five years if product is installed in a coastal region. Antique Brass finish is NOT available.



# SCHLAGE® CLASSIC HARDWARE

Schlage Classic hardware can fill your needs when you desire something understated, yet beautiful and lasting. Choose from an assortment of finishes.

## SCHLAGE CLASSIC HARDWARE FINISHES

Lifetime Bright Brass

Lifetime Satin Nickel

Lifetime Antique Brass

Lifetime Black

Lifetime finish warranty time period is limited to five years if product is installed in a coastal region.

Antique Brass finish is NOT available.

## SCHLAGE CLASSIC DOOR LOCKSETS AND DEADBOLTS



Accent/Addison  
Keyed Lockset\*



Accent Keyed  
Lockset



Exterior Interior  
Georgian Key in  
Knob Lockset



Flair Keyed  
Lockset



Latitude Lever with Century  
Trim Keyed Lockset §



Latitude Lever with Collins  
Trim Keyed Lockset ‡



Addison Trim \*



Exterior Interior  
Maximum Security  
Double Key  
1" Deadbolt ◊



Interior Only 1-Sided  
Thumbturn 1" Deadbolt ◊  
(Only available in 20-Gauge  
Steel or Signet Fiberglass)



Century Trim §



Thumbturn 1"  
Deadbolts

◊ Interior Only 1-Sided Thumbturn Deadbolts on any door which is used for egress may be a safety hazard in times of emergency. Double Key Deadbolts on any door which is used for egress are a safety hazard in times of emergency.

\* Not available in Bright Brass finish

‡ Only available in Satin Nickel finish

§ Only available in Satin Nickel and Lifetime Black finish

## SCHLAGE PASSAGE LATCHES



Accent/Addison  
Passage Latch\*



Accent  
Passage Latch



Latitude Lever with  
Century Trim §



Latitude Lever  
with Collins Trim ‡



Flair  
Passage Latch



Georgian  
Passage Latch

## OPTIONAL ACCESSORIES

Sometimes the smallest things make the biggest difference. Our accessories add a lot to the look of your entry system.



Colonial Door Knocker



Classic Door Knocker



Classic Door Knocker/Viewer



Mail Slot or Magazine Slot\*  
(NOT tested for Certified Wind Load or Impact Shield regions)  
(Doors with Mail Slot or Magazine Slot are not ENERGY STAR® certified)



1/8" Peepsite\*\*



Kick Plate

### Decorative Hinges

Also available in Satin Nickel & Oil Rubbed Bronze (Inswing only)

NOT tested for Impact Shield regions.

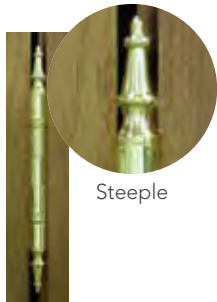

Steeple



Ball

## FINISHES

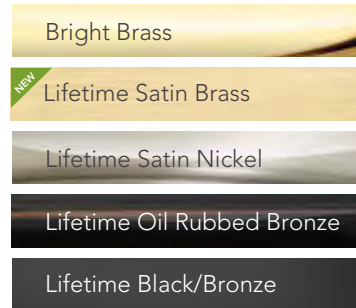

## ACCESSORIES FINISH AVAILABILITY 5-Year Mechanical Warranty

Accessories	Lifetime Finish				5-Year Finish		No Finish Warranty	Impact Shield 5-Year Finish
	Bright Brass	Satin Brass	Satin Nickel	Black/Bronze	Bright Brass	Antique Brass	Oil Rubbed Bronze	Bright Brass, Satin Nickel, Black/Bronze and Satin Brass
Colonial Door Knocker	•		•				•	• (N/A Black/Bronze)
Classic Door Knocker/Viewer	•	•	•	•	•	•		•
Classic Door Knocker	•	•	•	•	•	•		•
Magazine Slot*	•	•	•	•	•	•		
Mail Slot*	•	•	•	•	•	•		
Kick Plate	•	•	•	•	•	•		•

\* Mail slot and magazine slot are not available on 003C, 006C, 008P, 009, 420-DS, 420-2P, 420-3P, 110, 243, 440, 240, 449, 460, & 350 door styles. Additionally, magazine slots are also not available on 002C-449 & 003 door styles.

\*\* Peepsite available in Bright Brass, Chrome (recommended for use with Satin Nickel hardware finish) and Aged/Antique (recommended for use with Black, Oil Rubbed Bronze or Antique Brass hardware finish) with 5-year finish warranty.



# OPTIONS

The Hinge Straps, Clavos and Speakeasy are options that can give your entryway an old world look. Combine these options with our Signet® Knotty Alder Series to achieve a rustic or antique style. Hinge Straps, Clavos and Speakeasy are constructed of durable flat black aluminum.

**HINGE STRAPS** Available on all door styles shown on opposite page

 Available as an Impact Shield product.



**CLAVOS** Available only on door styles shown with planks on opposite page  
(002CP-449, 002CP-437, 8' 002CP-449 and 8' 002CP-437)

 Available as an Impact Shield product.





**SPEAKEASY** Available on all door styles shown below except for 8' 002C-437 and 8' 002CP-437

NOT tested for Certified Wind Load or Impact Shield regions. (Doors with Speakeasy are not ENERGY STAR® certified.)  
 ProVia® does not recommend entry doors with Speakeasy applications in the Northern climate zone. We also recognize some of the North-Central climate zone areas are not suitable for this application as well. We recommend this application to be used only in the South-Central and Southern climate zones. Speakeasy applications carry a 5-year limited warranty. See price book for more details.



Exterior



Interior

**IRON DOOR**

Not available on Embarq



Exterior



Interior

**SEA SPRAY GLASS DOOR**

(single pane)

Not available on Embarq

**FAUX SPEAKEASY**

Enjoy the decorative look of a speakeasy without impeding the energy efficiency of the entry door. Available on all door styles shown below.



**SIGNET® & EMBARQ® FIBERGLASS DOOR STYLES**

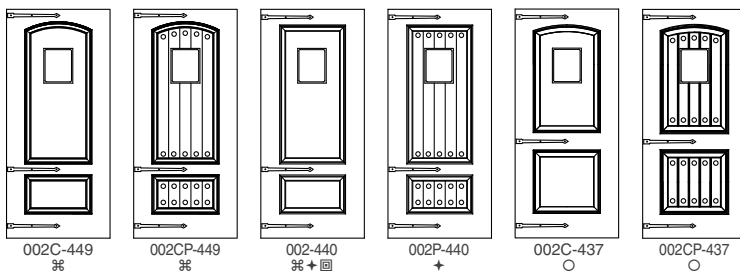

**8' SIGNET FIBERGLASS DOORS**

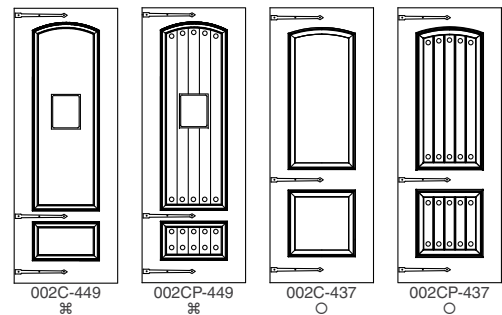

- ⌘ Signet/Embarq Cherry
- + Signet/Embarq Oak
- Signet/Embarq Knotty Alder
- Signet Smooth

Options

# OPTIONS



## PlexiDor® PET DOOR

(NOT available in Certified Wind Load or Impact Shield regions)  
(Doors with Pet Door are not ENERGY STAR® certified)

Factory Installed - Available on Flush Doors Only

- Shatter resistant saloon-styled door panels provide durability and insulation
- Thermo-pane panels lined with high density weather seal for maximum energy efficiency
- Includes lock, two keys & steel security plate
- Available in White, Silver, and Bronze frames
- Available on the following styles: 001, 430DC-F, 430VNT-F, 430DC-EG-F, 430DC-IGT-F, 100DC, 101DC, 131DC & 306DC

Medium: 9" x 12" opening for pets up to 40 lbs.  
Large: 11¾" x 16" opening for pets up to 100 lbs.  
X-Large: 15¾" x 23⅝" opening for pets up to 220 lbs.



## FREEDOM® PET DOOR

(NOT available in Certified Wind Load or Impact Shield regions)  
(Doors with Pet Door are not ENERGY STAR® certified)

Factory Installed - Available on Flush Doors Only

- Solid aluminum construction with locking panel
- Soft single flap for tight weather seal
- Antique White mitered aluminum frame
- Available on the following styles: 001, 430DC-F, 430VNT-F, 430DC-EG-F, 430DC-IGT-F, 100DC, 101DC, 131DC & 306DC
- Also available on storm doors. See pg. 156.

Medium: 8¼" x 12¼" opening for pets up to 40 lbs.  
Large: 10¼" x 16¼" opening for pets up to 100 lbs.  
X-Large: 13¾" x 23¾" opening for pets up to 220 lbs.

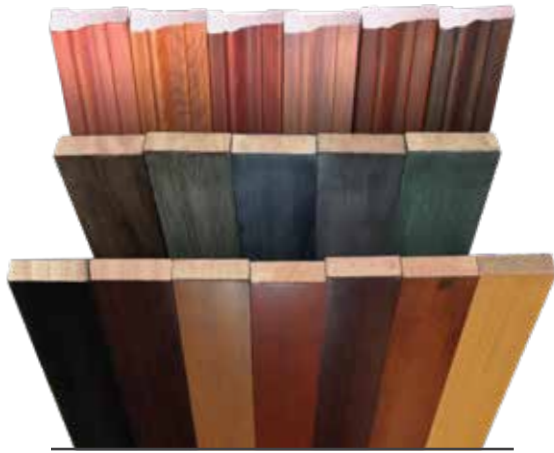

## CASING

Put the finishing touch on the inside of your entryway with our beautiful interior casing. Available in Cherry, Mahogany, Fir, Oak or Poplar wood.



2 1/2" Modern ▲



2 1/2" Colonial ▲



3 1/2" Colonial ▲



2 1/2" Flat\*



3 1/2" Flat\*

Available for any door configuration including transoms.

Signet® stains are available on Cherry, Mahogany, Oak or Fir casing, and Heritage™ and Legacy™ stains are available on Oak or Poplar casing. Paint and glazed finishes are available on Poplar casing.

### Custom Casing

Don't see a casing style you need? We have a custom casing program that can meet your needs. Contact your dealer for additional information on our Custom Casing program.

\* Only available in Fir and Poplar

▲ NOT available in Fir



3" Wide Brickmold  
Choose from our standard 2" brickmold or our wider 3" brickmold.

## ALUMINUM PRE-FIT CLADDING

Cladding is worth the small investment. You can add cladding to any FrameSaver® or PermaTech™ Composite Frame.

- Protective
- Maintenance-free
- Stays beautiful
- Factory applied

### TEXTURED CLADDING COLORS

Snow Mist	Café Cream	Chateau
Sandpiper Beige	Sandstone	Sterling Gray
Clay	Geneva Blue	Forest Green
Enzian Blue	Vallis Red	Mountain Berry
Tudor Brown	Oak	Cherry
Rustic Bronze	Coal Black	Nightfall

### TUFTEX SMOOTH CLADDING COLORS

Aluminum trim coil with mar-resistant smooth finish.

Snow Mist	Sandpiper Beige	Sandstone◊	Classic Bronze*
-----------	-----------------	------------	-----------------

◊ Smooth Sandstone cladding is a close match, but not an exact match to Sandstone paint color.

\* Smooth Classic Bronze cladding does not match Rustic Bronze cladding color or Rustic Bronze paint color.